

## Review

# The tumor suppressor RASSF1A in human carcinogenesis: an update

R. Dammann<sup>1</sup>, U. Schagdarsurengin<sup>1</sup>, C. Seidel<sup>1</sup>, M. Strunnikova<sup>1</sup>, M. Rastetter<sup>1</sup>, K. Baier<sup>1</sup> and G.P. Pfeifer<sup>2</sup>

<sup>1</sup>AG Tumorgenetik der Medizinischen Fakultät, Martin-Luther-Universität Halle-Wittenberg, Germany and

<sup>2</sup>Department of Biology, Beckman Research Institute, City of Hope Cancer Center, Duarte, California, USA

**Summary.** Loss of heterozygosity of the small arm of chromosome 3 is one of the most common alterations in human cancer. Most notably, a segment in 3p21.3 is frequently lost in lung cancer and several other carcinomas. We and others have identified a novel Ras effector at this segment, which was termed Ras Association Domain family 1 (RASSF1A) gene. RASSF1 consists of two main variants (RASSF1A and RASSF1C), which are transcribed from distinct CpG island promoters. Aberrant methylation of the RASSF1A promoter region is one of the most frequent epigenetic inactivation events detected in human cancer and leads to silencing of RASSF1A. Hypermethylation of RASSF1A was commonly observed in primary tumors including lung, breast, pancreas, kidney, liver, cervix, nasopharyngeal, prostate, thyroid and other cancers. Moreover, RASSF1A methylation was frequently detected in body fluids including blood, urine, nipple aspirates, sputum and bronchial alveolar lavages. Inactivation of RASSF1A was associated with an advanced tumor stage (e.g. bladder, brain, prostate, gastric tumors) and poor prognosis (e.g. lung, sarcoma and breast cancer). Detection of aberrant RASSF1A methylation may serve as a diagnostic and prognostic marker. The functional analyses of RASSF1A reveal an involvement in apoptotic signaling, microtubule stabilization and mitotic progression. The tumor suppressor RASSF1A may act as a negative Ras effector inhibiting cell growth and inducing cell death. Thus, RASSF1A may represent an epigenetically inactivated *bona fide* tumor suppressor in human carcinogenesis.

**Key words:** RASSF1A, Cancer, Methylation, Cell cycle, Apoptosis, Ras

## Introduction

Deletion of the short arm of chromosome 3 is the earliest and most common alteration, which occurs in the pathogenesis of lung cancer. Several distinct regions are lost, including 3p12, 3p14, 3p21 and 3p24-25 (Kok et al., 1997). In these segments, the van Hippel-Lindau disease (VHL) gene at 3p25 (Kaelin and Maher, 1998), the gene FHIT at 3p14.2 (Sozzi et al., 1996), and the DUTT1/ROBO1 gene at 3p12 (Xian et al., 2001) have been identified. At segment 3p21.3 heterozygous and homozygous deletions have been described in several cancer cell lines and in primary lung tumors (Killary et al., 1992; Yamakawa et al., 1993; Wei et al., 1996; Kok et al., 1997; Todd et al., 1997; Wistuba et al., 2000). Allelic loss at 3p21.3 is not limited to lung cancer indicating that this segment may encode a general tumor suppressor. Other tumors with 3p21 involvement include head and neck cancer, renal cell carcinoma, bladder cancer, female genital tract tumors and breast cancer (Kok et al., 1997). The region of minimum homozygous deletion at 3p21.3 was narrowed to a fragment of 120 kb using several cancer cell lines (Sekido et al., 1998). Eight genes located in this region have been isolated as candidate tumor suppressor genes (Lerman and Minna, 2000). However, confirmation of these genes as tumor suppressors has been difficult, since mutations in these genes were rarely detected in tumors. Recently, we and others have cloned the RASSF1 gene from the common homozygous deletion area at 3p21.3 (Dammann et al., 2000; Lerman and Minna, 2000; Burbee et al., 2001).

**Abbreviations:** RASSF, Ras-association domain family; NORE, Novel Ras effector; LOH, Loss of heterozygosity; RA domain, RalGDS/AF6 Ras-association domain; aa, amino acid; 5-aza-CdR, 5-aza-2'-deoxycytidine; SV40, simian virus 40; EBV, Epstein-Barr virus; HPV, human papilloma virus ATM, ataxia telangiectasia mutated; DAG, diacylglycerol; C1, protein kinase C conserved region 1; SCC, squamous cell carcinoma; AC, adenocarcinoma; SCLC, small cell lung cancer; NSCLC, non-small cell lung cancer

*RASSF1* was isolated in a yeast two-hybrid screen and its cDNA matched the sequences of the minimum homozygous deletion fragment of 120 kb (Dammann et al., 2000). The C-terminus of RASSF1 shows high homology to the mammalian Ras-effector protein Nore1 (Vavvas et al., 1998) and encodes a Ras-association domain (Fig. 1). Therefore, the gene has been named Ras-association domain family 1 gene (Dammann et al., 2000). Additional cDNA screenings revealed the presence of seven alternatively spliced transcripts: RASSF1A to RASSF1G (Dammann et al., 2000, 2003b). The three major forms: RASSF1A, RASSF1C and RASSF1F are transcribed from two different CpG island promoters, which are approximately 3.5 kb apart (Fig. 1). RASSF1A and RASSF1C have four common exons (3 to 6) at their 3' end encoding the Ras Association domain (Fig. 1) (Ponting and Benjamin, 1996). The N-terminus of RASSF1A has high homology to a cysteine-rich diacylglycerol/phorbol ester-binding (DAG) domain, also known as the protein kinase C conserved region 1 (C1), which contains a central C1 zinc finger (Newton, 1995). The protein sequence of RASSF1C translated from the first exon 2 $\gamma$  has no significant similarity to any known protein. The aa sequence W125 to K138 of RASSF1A matches a putative ATM kinase phosphorylation consensus motif and a peptide with this sequence is effectively phosphorylated in vitro (Kim et al., 1999). The RASSF1F transcript skips exon 2 $\alpha\beta$  and encodes a truncated peptide of 92 amino acids, which contains the DAG-binding domain (Burbee et al., 2001). The RASSF1A and RASSF1F transcripts are frequently detected in normal tissue, but are missing in several

cancer cell lines and primary tissues (Dammann et al., 2000, 2003b; Pfeifer et al., 2002). Silencing of RASSF1A is due to aberrant methylation of its CpG island promoter and RASSF1A is reexpressed by inhibiting DNA methyltransferase in cancer cells (Dammann et al., 2000). In this review, novel findings related to the epigenetic inactivation and function of the RASSF1A protein are presented and discussed.

### Methylation analyses of RASSF1A in human tumors

Silencing of tumor suppressor genes by epigenetic modification is a fundamental inactivation mechanism of cancer-related genes in the pathogenesis of human cancer (Jones and Baylin, 2002). Particularly, promoter hypermethylation plays an essential role in loss of function of tumor suppressor genes (Herman and Baylin, 2003). Aberrant promoter methylation of RASSF1A was frequently detected in several tumor entities and correlated with additional findings (Table 1). In bladder cancer, high frequency of RASSF1A methylation was observed and was correlated with advanced tumor stage and poor prognosis (Lee et al., 2001; Maruyama et al., 2001; Chan et al., 2003; Dulaimi et al., 2004b). In brain cancer, RASSF1A methylation was often detected in neuroblastoma, glioblastoma and medulloblastoma, however it was less frequent found in benign tumors (Astuti et al., 2001; Lusher et al., 2002; Balana et al., 2003; Horiguchi et al., 2003; Ramirez et al., 2003b; Astuti et al., 2004; Hesson et al., 2004; Lindsey et al., 2004). Methylation of RASSF1A was frequently found in breast cancer and in serum of breast cancer patients (Agathangelou et al., 2001; Burbee et al., 2001; Dammann et al., 2001b; Lehmann et al., 2002; Chen et al., 2003a; Fackler et al., 2003; Honorio et al., 2003a; Muller et al., 2003; Krassenstein et al., 2004; Mehrotra et al., 2004). In cervical cancer, RASSF1A promoter methylation was found in certain tumor types (Table 1) (Agathangelou et al., 2001; Cohen et al., 2003; Kuzmin et al., 2003; Yu et al., 2003). Kuzmin et al. (2003) have reported an inverse correlation between methylation of RASSF1A and human papilloma virus infection. In cholangiocarcinoma, 69% of RASSF1A promoter hypermethylation were observed (Wong et al., 2002). In colorectal carcinoma, RASSF1A methylation was less frequently found (Yoon et al., 2001; Wagner et al., 2002; van Engeland et al., 2003; Lee et al., 2004). Interestingly, RASSF1A methylation occurs significantly in colorectal carcinoma with K-ras wild type (van Engeland et al., 2002). In 52% of esophageal squamous cell carcinoma, RASSF1A methylation was reported and correlated with an advanced tumor stage (Kuroki et al., 2003). In gastric cancer, RASSF1A hypermethylation was more frequently found in the advanced tumor stage and in EBV positive carcinoma (Table 1); however, RASSF1A methylation was rarely detected in non-carcinoma tumor samples (Byun et al., 2001; Kang et al., 2002, 2003a,b; To et al., 2002; House et al., 2003a). In head and neck cancer, RASSF1A

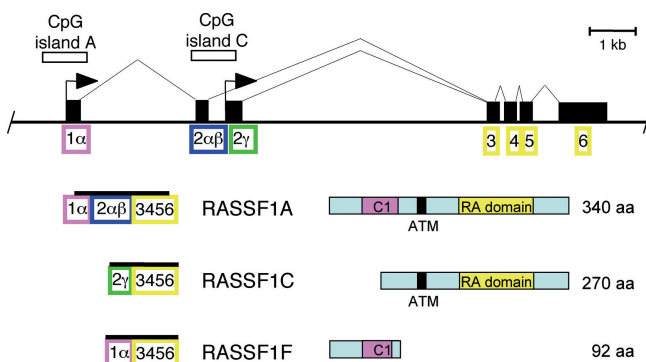

**Fig. 1.** Map of the RASSF1 gene. The two promoters of RASSF1 (arrows) are located in CpG islands (open square). Three major isoforms (RASSF1A, RASSF1C and RASSF1F) are made by alternative promoter usage and splicing of the exons (black boxes). The cDNA of RASSF1A is 1.9 kb long and contains an ORF of 340 amino acids (aas) with a calculated MW of 38.8 kDa. Transcript RASSF1C is 1.7 kb long and initiates in exon 2 $\gamma$  located at the CpG island C. The cDNA encodes a 270 aas protein with a MW of 31.2 kDa. The RASSF1F transcript skips exon 2 $\alpha\beta$  and encodes a truncated peptide of 92 aas. The protein domains are indicated as: DAG, diacylglycerol/phorbol ester binding domain; RA, RalGD/AF6 Ras-association domain; and ATM putative ATM phosphorylation site consensus sequence.

*RASSF1A in human cancer***Table 1.** Methylation analysis of RASSF1A in human tumors.

TUMOR	PERCENT OF METHYLATION IN PRIMARY TUMORS	REFERENCE	ADDITIONAL OBSERVATIONS
Bladder cancer	60% (33/55)	Lee et al., 2001	Inactivation of RASSF1A was correlated with advanced tumor stage
	35% (34/98)	Maruyama et al., 2001	RASSF1A methylation correlated with parameters of poor prognosis
	48% (19/40)	Chan et al., 2003	RASSF1A methylation was more frequent in cases with LOH at 3p21.3 (73%) compared to cases without LOH (13%; p=0.007). RASSF1A methylation was found in 50% (7/14) of urine samples; no false positives and all samples that showed methylation in the tumor were methylated in the urine.
	51% (23/45)	Dulaimi et al., 2004b	RASSF1A hypermethylation was found in all pathological grades and stages of bladder cancer and in patients of all ages; in 87% (39/45) of the cases hypermethylation of RASSF1A, APC or p14ARF could be detected in urine of the bladder cancer patients.
Brain cancer	55% (37/67)	Astuti et al., 2001	Neuroblastoma; RASSF1A was reexpressed after treatment with 5-aza-CdR in neuroblastoma cell lines
	54% (25/46)	Horiguchi et al., 2003	Glioma
	100% (5/5)	Horiguchi et al., 2003	Medulloblastoma
	10% (1/10)	Horiguchi et al., 2003	Schwannoma (benign)
	17% (2/12)	Horiguchi et al., 2003	Meningioma (benign)
	79% (27/34)	Lusher et al., 2002	Epigenetic inactivation by biallelic hypermethylation represents the primary mechanism of RASSF1A inactivation in medulloblastoma.
	93% (41/44)	Lindsey et al., 2004	Medulloblastoma; in 57% of the cases a total methylation was detected; methylation in all histopathological and clinical disease subtypes; 100% (11/11) in medulloblastoma cell lines and RASSF1A was reexpressed after treatment with 5-aza-CdR
	57% (36/63)	Hesson et al., 2004	Glioma; RASSF1A methylation increased with tumor grade (40% grade II, 53% grade III, 63% grade IV); no association between RASSF1A and BLU methylation; 100% (7/7) in glioma cell lines; reexpression of RASSF1A suppressed the growth of glioma cell line.
	57% (12/21)	Balana et al., 2003	Glioblastoma; a tendency for a longer time to progression for patients with methylated RASSF1A promoter was observed; 50% (13/26) in serum samples
	57% (16/28)	Ramirez et al., 2003b	Glioblastoma, 50% in serum; high correlation between methylation in tumor and serum was observed (Spearman test p=0.0001)
Breast cancer	55%	Astuti et al., 2004	Neuroblastoma; RASSF1A promoter hypermethylation was more frequent in neuroblastomas with SLIT2 promoter methylation (p=0,32); inverse relationship between SLIT2 and RASSF1A promoter hypermethylation in Wilms tumor (p=0,09); no associations with clinicopathological features
	62% (28/45)	Dammann et al., 2001b	RASSF1A was reexpressed after treatment with 5-aza-CdR in breast cancer cell lines
	9% (4/44)	Agathangelou et al., 2001	
	49% (19/39)	Burbee et al., 2001	
	56% (20/36)	Lehmann et al., 2002	RASSF1A methylation was detected in epithelial hyperplasia, but not in normal tissue
	58% (54/93)	Chen et al., 2003	
	65% (11/17)	Honorio et al., 2003a	Invasive breast cancer
	42% (5/12)	Honorio et al., 2003a	Ductal carcinoma in-situ
	62% (8/13)	Fackler et al., 2003	Lobular carcinoma in-situ
	84% (16/19)	Fackler et al., 2003	Invasive lobular cancer
	70% (19/27)	Fackler et al., 2003	Invasive breast cancer
	75%	Fackler et al., 2003	Ductal carcinoma in-situ
	23% (n=26)	Muller et al., 2003	Serum DNA from primary breast cancer patients: patients with methylated RASSF1A and/or APC serum DNA was strongly associated with poor outcome, with a relative risk for death of 5.7 (p<0.001); 80% (n=10) in serum DNA from recurrent breast cancer patients).

*RASSF1A in human cancer***Table 1.** Continued.

TUMOR	PERCENT OF METHYLATION IN PRIMARY TUMORS	REFERENCE	ADDITIONAL OBSERVATIONS
Breast cancer	56% (14/25)	Mehrotra et al., 2004	Primary breast cancer, additional analyses of metastases : 78% (7/9) bone; 67% (4/6) brain; 100% (10/10) lung; higher prevalence of methylation in lymph node metastasis than in primary tumors
	62%	Krassenstein et al., 2004	Hypermethylation in nipple aspirates was detected in matched breast tumor cases
Cervix cancer	0% (0/22)	Agathangelou et al., 2001	Squamous cell carcinoma; 41 % hypermethylation among the group of SCC with 3p21 allelic loss whereas only 21% of SCC with retention of 3p21 demonstrated RASSF1A hypermethylation
	30% (10/33)	Yu et al., 2003	
	12% (2/17)	Yu et al., 2003	Adenocarcinoma; no correlation between RASSF1A hypermethylation and age of patient, HPV genotype, tumor grade or stage was observed
	10% (4/42)	Kuzmin et al., 2003	Squamous cell carcinoma
	21% (4/19)	Kuzmin et al., 2003	Adenosquamous carcinoma
	24% (8/34)	Kuzmin et al., 2003	Adenocarcinoma; significant reverse correlation between inactivation of RASSF1A and the presence of high-risk HPV was observed in cervical tumors and cell lines ( $p < 0.04$ ).
	45% (9/20)	Cohen et al., 2003	Adenocarcinoma; HPV 16 DNA was found in 3/9 (33%) AC with RASSF1A methylation and 5/11 (45%) AC without RASSF1A methylation; no inverse correlation between RASSF1A methylation and HPV 16 infection in AC of the uterine cervix was found.
	0% (0/31)	Cohen et al., 2003	Squamous cell carcinoma
Cholangiocarcinoma	69% (9/13)	Wong et al., 2002	Expression of RASSF1A in nine cases with promoter methylation indicated reduced expression compared to normal livers.
Colorectal cancer	12% (3/26)	Yoon et al., 2001	RASSF1A methylation occurs predominantly in K-ras wild type colorectal carcinomas ( $p = 0.023$ )
	20% (45/222)	van Engeland et al., 2002	
	45% (13/29)	Wagner et al., 2002	RASSF1A was reexpressed after treatment with 5-aza-CdR in a colon cancer cell line
	20% (25/122)	van Engeland et al., 2003	Sporadic colorectal cancer; data suggest that folate and alcohol intake may be associated with changes in promoter hypermethylation.
	16% (n=149)	Lee et al., 2004	Colorectal carcinoma
	2% (n=95)	Lee et al., 2004	Colorectal adenoma; methylation of RASSF1A is a late event: RASSF1A is rarely methylated in adenoma but significantly methylated in colorectal carcinoma ( $p < 0.001$ ). CpG island methylation plays a more important role in proximal colon tumorigenesis rather than in distal colon tumorigenesis (10.7% (n=56) right colon vs. 19.4% (n=93) in the left colon).
Esophageal cancer	52% (25/48)	Kuroki et al., 2003	SSC; significant correlation between RASSF1A methylation and advanced tumor stage was detected ( $p = 0.009$ , stage I/II vs. stage III/IV).
Gastric cancer	43% (39/90)	Byun et al., 2001	Inactivation of RASSF1A was correlated with advanced tumor stage
	67% (14/21)	Kang et al., 2002	Epstein-Barr virus-positive carcinoma
	4% (2/56)	Kang et al., 2002	Epstein-Barr virus-negative carcinoma
	26% (8/31)	To et al., 2002	No significant correlation between methylation of RASSF1A and clinicopathological characteristics of the tumors was found. 11% of the gastric intestinal metaplasia samples showed hypermethylation.
	8% (6/80)	Kang et al., 2003b	RASSF1A methylation was found only in gastric cancer. No RASSF1A methylation was observed in gastric adenoma (n=79), intestinal metaplasia (n=57) and chronic gastritis (n=74).
	40%	House et al., 2003a	Gastrointestinal stromal tumor
	0,4 % (n=268)	Kang et al., 2003a	Gastric mucosa samples

*RASSF1A in human cancer*

Table 1. Continued.

TUMOR	PERCENT OF METHYLATION IN PRIMARY TUMORS	REFERENCE	ADDITIONAL OBSERVATIONS
Head and neck cancer	8% (6/80)	Hasegawa et al., 2002	
	17% (4/24)	Hogg et al., 2002	RASSF1A methylation was higher in poorly differentiated SCC (p<0.005)
	15% (7/46)	Dong et al., 2003	A significant inverse correlation between RASSF1A promoter methylation and HPV infection was found (p=0.038).
	0% (0/32)	Maruya et al., 2004	Primary tumors SSC, 26% (5/19) methylation in cancer cell lines
Hepatocellular carcinoma	100% (29/29)	Yu et al., 2003	RASSF1A was less frequently methylated in the adjacent non-cancerous liver tissue (24/29, 83%).
	93% (14/15)	Schagdarsurengin et al., 2003	RASSF1A inactivation by methylation is a frequent event in HCC, but was not detected in adenoma.
	95% (41/43)	Zhong et al., 2003	The level of methylation in non-tumor tissue was significantly lower than in the corresponding tumor tissue.
	67% (40/60)	Lee et al., 2003	Hepatocellular carcinoma (HCC)
	9% (2/22)	Lee et al., 2003	Dysplastic nodule (DN); no methylation in 30 liver cirrhosis (LC) and 34 chronic hepatitis (CH): HCC vs. DN p>0.001; HCC vs. LC p<0.001; no correlations with age, sex, stage, survival time.
Kidney cancer	56% (18/32)	Yoon et al., 2001	Renal cell carcinoma
	91% (39/43)	Dreijerink et al., 2001	Ectopic re-expression of RASSF1A suppressed growth in vitro
	23% (32/138)	Morrissey et al., 2001	clear cell renal cell carcinoma; RASSF1A was re-expressed after treatment with 5-aza-CdR in cancer cell lines
	44% (12/27)	Morrissey et al., 2001	Papillary renal cell carcinoma
	52% (26/50)	Battagli et al., 2003	Kidney tumor; RASSF1 methylation was detected in urine DNA
	100% (6/6)	Battagli et al., 2003	Papillary kidney tumor; association of RASSF1A hypermethylation and papillary tumors was statistically significant (p=0.022)
	44% (19/43)	Battagli et al., 2003	Non-papillary renal cell carcinoma
	45%	Dulaimi et al., 2004a	Kidney tumors; RASSF1A methylation was detected at a significant higher frequency in papillary tumors (p=0.011) and in high grade tumors (p=0.003). Inverse correlation between hypermethylation of RASSF1A and p14 or APC. No correlation with survival time.
	46% (23/50)	Dulaimi et al., 2004a	Clear cell renal cell carcinoma
	70% (14/20)	Dulaimi et al., 2004a	Papillary kidney tumor
	17% (1/6)	Dulaimi et al., 2004a	Chromophobe kidney tumor
	14% (1/7)	Dulaimi et al., 2004a	Oncocytoma
	60% (3/5)	Dulaimi et al., 2004a	Kidney tumor of the collecting duct
	33% (2/6)	Dulaimi et al., 2004a	Transitional cell carcinoma of the renal pelvis
Lung cancer	38% (22/58)	Dammann et al., 2000	Non-small cell lung cancer (NSCLC); exogenous expression of RASSF1A inhibited growth of lung cancer cells in vitro and in vivo
	28% (7/25)	Dammann et al., 2000	Adenocarcinoma
	58% (8/14)	Dammann et al., 2000	Large cell carcinoma
	37% (7/19)	Dammann et al., 2000	Squamous cell carcinoma
	79% (22/28)	Dammann et al., 2001a	Small cell lung cancer (SCLC);
	72% (21/29)	Agathangelou et al., 2001	SCLC
	34% (14/41)	Agathangelou et al., 2001	NSCLC
	30% (32/107)	Burbee et al., 2001	NSCLC; methylation of RASSF1A was associated with impaired patient survival (p=0.046)
	32% (35/110)	Tomizawa et al., 2002	RASSF1A methylation correlated with adverse survival of lung adenocarcinoma patients
	71%	Toyooka et al., 2001b	Atypical carcinoids.
	45%	Toyooka et al., 2001b	Typical carcinoids ; methylation frequency of RASSF1A was significantly higher in neuroendocrine tumors than in the NSCLC tumors (p<0.0001); methylation of RASSF1A was higher in SCLC tumors than in bronchial carcinoids (p=0.002)

*RASSF1A in human cancer***Table 1.** Continued.

TUMOR	PERCENT OF METHYLATION IN PRIMARY TUMORS	REFERENCE	ADDITIONAL OBSERVATIONS
Lung cancer	36% (107/299)	Toyooka et al., 2003	Adenocarcinoma; no significant differences in methylation status of RASSF1A between smokers and non-smokers.
	37% (72/194)	Toyooka et al., 2003	Squamous cell carcinoma
	21% (5/24)	Honorio et al., 2003a	No correlation between tumor stage, location and RASSF1A methylation status in sputum samples of NSCLC patients. 50% (n=8) SCLC showed methylation in sputum.
	42% (42/100)	Endoh et al., 2003	In the cases of stage I and II diseases RASSF1A methylation was associated with earlier recurrence (p=0.0247).
	32% (66/204)	Kim et al., 2003a	Hypermethylation of the RASSF1A promoter was found to be significantly associated with the age of starting smoking (p=0.001). RASSF1A promoter was found to be associated with a poor prognosis in NSCLC patients at stages 1 and 2 (p=0.02 and 0.01, respectively).
	33% (80/242)	Kim et al., 2003b	NSCLC; RASSF1A methylation was not associated with K-ras mutations (p=0.37); RASSF1A methylation more frequently in adenocarcinomas (39%) than in squamous cell carcinomas (26%); the hazard of failure for those with RASSF1A methylation was higher compared with that of those with neither K-ras mutation nor RASSF1A methylated (p=0.01).
	43% (32/75)	Yanagawa et al., 2003	Methylation of RASSF1A was cancer-specific (p<0.05).
	45%	Li et al., 2003	NSCLC; the results indicate a trend of inverse relationship between K-ras activation and RASSF1A promoter methylation
	55%	Li et al., 2003	Adenocarcinoma
	25%	Li et al., 2003	Large cell carcinoma
	25%	Li et al., 2003	Squamous cell carcinoma
	34% (17/50)	Ramirez et al., 2003a	NSCLC; 34% in serum of patients, correlation between methylation in tumor and serum was observed (p=0.0001)
	47% (7/15)	Ramirez et al., 2003a	Adenocarcinoma
	40% (4/10)	Ramirez et al., 2003a	Large cell carcinoma
	24% (6/25)	Ramirez et al., 2003a	Squamous cell carcinoma
	30% (32/107)	Zochbauer-Muller et al., 2003	NSCLC; additional analysis of bronchial brushes (6%), bronchoalveolar lavage (5%) and oropharyngeal brushes (4%); methylation events more often in samples of smokers
41% (51/124)	Maruyama et al., 2004	NSCLC	
45% (14/31)	Topaloglu et al., 2004	NSCLC; methylation detected in 29% (4/14) bronchoalveolar lavage of tumor patients	
52% (12/21)	Topaloglu et al., 2004	Adenocarcinoma	
Lymphoma	65% (34/52)	Murray et al., 2004	Hodgkin's lymphoma; 83% (5/6) in non-Hodgkin lymphoma cell lines; hypermethylation in serum samples: 9% (2/22)
Melanoma	55% (24/44)	Spugnardi et al., 2003	Malignant cutaneous melanoma
	41% (18/44)	Spugnardi et al., 2003	Region upstream from exon 1 $\alpha$ of RASSF1A
	50% (22/44)	Spugnardi et al., 2003	Region within exon 1 $\alpha$ of RASSF1A
	15% (3/20)	Hoon et al., 2004	Primary tumors; hypermethylation of RASSF1A increases during tumor progression
	57% (49/86)	Hoon et al., 2004	Metastatic tumors; RASSF1A methylation in 19% (n=6) of plasma from preoperative blood specimen
	53%	Reifenberger et al., 2004	Transcriptional downregulation of RASSF1A does not function as an alternative mechanism to oncogenic BRAF or N-ras mutation in melanomas
Mesothelioma	32% (21/66)	Toyooka et al., 2001a	Malignant mesothelioma; inactivation of RASSF1A was correlated with the presence of SV40 in mesothelioma (p=0.022).

*RASSF1A in human cancer***Table 1.** Continued.

TUMOR	PERCENT OF METHYLATION IN PRIMARY TUMORS	REFERENCE	ADDITIONAL OBSERVATIONS
Myeloma	28% (9/32)	Ng et al., 2003	Multiple myeloma; no mutation of RASSF1A and BRAF
	15% (17/113)	Seidl et al., 2004	Multiple myeloma
	14% (4/29)	Seidl et al., 2004	Monoclonal gammopathie of undetermined significance
Nasopharyngeal carcinoma	67% (14/21)	Lo et al., 2001	Nasopharyngeal (NP) cancer no significant correlation between methylation of RASSF1A and clinical parameters
	50% (8/16)	Tong et al., 2002	RASSF1A methylation was detected in 39% of EBV associated NP brushing samples
	83% (24/29)	Kwong et al., 2002	
	67% (20/30)	Chang et al., 2003	Tumor tissue; methylation of RASSF1A in nasopharyngeal swabs (33%), mouth and throat rinsing fluid (37%) and peripheral blood (3%).
	46% (14/30)	Wong et al., 2003	Undifferentiated NP, methylation of RASSF1A in peripheral blood was detected in all samples with methylated tumor
	65%	Wong et al., 2004b	Methylation of RASSF1A was detected in 5% (2/41) of serum of patients with nasopharyngeal carcinoma; the plasma DNA concentration was higher in NPC patients than in normal individuals (p=0.175); Hypermethylated gene levels in plasma of NPC patients were not correlated with sex, clinical tumor staging, and lymph node status.
Osteosarcoma	40% (4/10)	Lim et al., 2003*	RASSF1A not expressed in 83% (5/6) cell lines; treatment of cell lines with 5-aza-2-deoxycytidine reactivated the transcription of RASSF1A, but not that of RASSF1B.
Ovarian cancer	10% (2/21)	Agathangelou et al., 2001	
	40% (8/20)	Yoon et al., 2001	
	41% (20/49)	Rathi et al., 2002	RASSF1A methylation frequency was significantly higher in sporadic ovarian cancer compared to nonmalignant tissue (P=0.01).
	36% (9/25)	Dhillon et al., 2004	
	50% (25/50)	de Caceres et al., 2004	Tumor specific methylation of RASSF1A was observed in serum, plasma and peritoneal fluid from cancer patients
Pancreatic carcinoma	64% (29/45)	Dammann et al., 2003	Pancreatic adenocarcinomas with K-ras mutation have significantly less RASSF1A methylation and vice versa (p=0.001); methylation was detected in 44% (8/18) of pancreatitis cases
	83% (10/12)	Dammann et al., 2003	Endocrine tumors
	75% (36/48)	House et al., 2003b	Endocrine tumors (ET); tumors larger than 5 cm and those associated with lymph node or hepatic metastases exhibited a higher frequency of methylation at RASSF1A compared with ET's without malignant histological features.
Pediatric tumors	40% (70/175)	Harada et al., 2002	42% in Wilms: tumor, 88% in medulloblastoma, 59% in retinoblastoma, 61% rhabdomyosarcoma, 52% neuroblastoma, 19% hepatoblastoma, 18% acute leukemia
	73% (22/30)	Ehrlich et al., 2002	Wilms' tumor
	54% (21/39)	Wagner et al., 2002	Wilms' tumor
	67% (16/24)	Wong et al., 2004a	Including neuroblastoma, thyroid cancer, hepatocellular carcinoma pancreatoblastoma, adrenocortical carcinoma, Wilms' tumor, Burkitt's lymphoma and T-Cell lymphoma; RASSF1A methylation was detected in 54%, 40% and 9% of buffy coat samples before, during and after treatment
Pheochromocytoma	22% (5/23)	Astuti et al., 2001	
	48% (12/25)	Dammann et al., 2005	RASSF1A methylation was more common in hereditary tumors (58%) compared to the sporadic tumors (38%)

## RASSF1A in human cancer

methylation frequency is less than 20% (Hasegawa et al., 2002; Hogg et al., 2002; Dong et al., 2003; Maruya et al., 2004). Dong et al. 2003 have reported an inverse correlation between RASSF1A methylation and HPV infection (Table 1). In hepatocellular carcinoma, intensive RASSF1A methylation was detected and methylation was also found in adjacent non-cancerous tissue, cirrhosis and hepatitis (Lee et al., 2003;

Schagdarsurengin et al., 2003; Yu et al., 2003; Zhong et al., 2003). In Hodgkins' lymphoma, 65% of RASSF1A methylation was reported (Murray et al., 2004). Several reports have investigated the methylation status of RASSF1A in renal cell carcinoma and kidney tumors (Dreijerink et al., 2001; Morrissey et al., 2001; Yoon et al., 2001; Battagli et al., 2003; Dulaimi et al., 2004a). In papillary renal cell carcinoma, RASSF1A was frequently

Table 1. Continued.

TUMOR	PERCENT OF METHYLATION IN PRIMARY TUMORS	REFERENCE	ADDITIONAL OBSERVATIONS
Prostate cancer	53% (54/101)	Maruyama et al., 2002	RASSF1A methylation was correlated with clinicopathological features of poor prognosis
	100% (11/11)	Kuzmin et al., 2002	Reintroduction of RASSF1A suppressed the growth of a prostate cancer cell line in vitro
	71% (37/52)	Liu et al., 2002	RASSF1A methylation frequency was higher in more aggressive tumors (p=0.032)
	84% (31/37)	Kang et al., 2004	The methylation frequency of RASSF1A was higher in prostate cancer with high serum PSA (prostate specific antigen) or with high GS (Gleason score) than those with low PSA or GS (p<0.05).
	66% (59/90)	Woodson et al., 2004b	No correlation between RASSF1A hypermethylation and tumor grade or stage or race of investigated patients was observed; in benign prostate hyperplasia (n=7) no RASSF1A methylation was found
	83% (20/24)	Woodson et al., 2004a	Frequency of methylation did not differ by tumor grade; 30% (3/10) of RASSF1A methylation was detected in high-grade prostatic intraepithelial neoplasia
	49%	Singal et al., 2004	RASSF1A methylation was found in 19% of benign prostatic hyperplasia
	78% (88/113)	Florl et al., 2004	
Soft tissue sarcoma	20% (7/84)	Seidel et al., in press	RASSF1A methylation was more frequent in leiomyosarcoma (39%) compared to malignant fibrous histiocytomas (6%) and liposarcomas (39%); tumor related death of cancer patients with methylated RASSF1A was significantly increased (p=0.037)
Testicular germ cell tumor	22% (20/92)	Koul et al., 2002	80% (8/10) of methylated tumors showed lack or down-regulation of RASSF1A expression.
	40% (4/10)	Honorio et al., 2003b	Seminomas
	83% (15/18)	Honorio et al., 2003b	Nonseminomas; RASSF1A methylation was significantly less in seminomas compared to nonseminomas (p=0.0346). RASSF1A methylation occurs early in tumorigenesis
	0% (0/25)	Kawakami et al., 2003	Testicular germ cell tumors; 100% (3/3) RASSF1A methylation in testicular malignant lymphomas
Thyroid cancer	36%	Koul et al., 2004	Nonseminoma; 52% in cisplatin resistant tumors vs. 28% in cisplatin sensitive tumors; RASSF1A may serve as a marker for cisplatin resistance; evidence for hypermethylation by cisplatin treatment
	71% (27/38)	Schagdarsurengin et al., 2002	RASSF1A methylation was more frequent in more aggressive thyroid carcinomas
	44% (4/9)	Xing et al., 2004	Follicular adenomas
	75% (9/12)	Xing et al., 2004	Follicular thyroid cancer
	20% (6/30)	Xing et al., 2004	Papillary thyroid cancer; in tumor cell lines and in PTCs an inverse correlation of RASSF1A methylation and BRAF mutation was found

\* Expression study



## RASSF1A in human cancer

inactivated (Table 1). Intensive methylation (>70%) of RASSF1A was reported in small cell lung cancer (SCLC). In non small cell lung cancer (NSCLC), RASSF1A hypermethylation is common and correlated with impaired prognosis (Dammann et al., 2000, 2001a; Agathangelou et al., 2001; Burbee et al., 2001; Toyooka et al., 2001b; Tomizawa et al., 2002; Endoh et al., 2003; Honorio et al., 2003a; Kim et al., 2003a,b; Li et al., 2003; Ramirez et al., 2003b; Toyooka et al., 2003; Yanagawa et al., 2003; Zochbauer-Muller et al., 2003; Maruyama et al., 2004; Topaloglu et al., 2004). In malignant mesothelioma, 32% of RASSF1A inactivation was found and correlated with the presence of SV40 (Toyooka et al., 2001a, 2002). In melanoma, frequent RASSF1A methylation was reported in three different studies (Spugnardi et al., 2003; Hoon et al., 2004; Reifenberger et al., 2004). Reifenberger et al. (2004) observed that tumors with RASSF1A methylation additionally carried BRAF and NRAS mutations, suggesting a synergistic effect of these aberrations on melanoma growth. In less than 30% of multiple myeloma cases, RASSF1A methylation was found (Ng et al., 2003; Seidl et al., 2004). In nasopharyngeal carcinoma, aberrant RASSF1A methylation was frequently (>50%) observed (Lo et al., 2001; Kwong et al., 2002; Tong et al., 2002; Chang et al., 2003; Wong et al., 2003, 2004b) and occurred in 39% of EBV associated nasopharyngeal carcinoma (Table 1). In 40% of osteosarcoma, hypermethylation of RASSF1A occurred (Lim et al., 2003). In ovarian cancer frequent RASSF1A methylation was demonstrated in several studies (Agathangelou et al., 2001; Yoon et al., 2001; Rathi et al., 2002; de Caceres et al., 2004; Dhillon et al., 2004). In endocrine tumors of the pancreas, the frequency of RASSF1A inactivation was higher compared to pancreatic adenocarcinoma (83% versus 64%) (Dammann et al., 2003a; House et al., 2003b). We have reported an inverse correlation between RASSF1A silencing and K-ras mutation in pancreatic cancer. In pediatric tumors, RASSF1A methylation was found in Wilms' tumor, medulloblastoma, retinoblastoma, rhabdomyosarcoma, neuroblastoma, hepatoblastoma, leukemia, pancreatoblastoma, adrenocortical carcinoma and lymphoma (Ehrlich et al., 2002; Harada et al., 2002; Wagner et al., 2002; Wong et al., 2004a). In hereditary pheochromocytoma, RASSF1A methylation was more common compared to the sporadic tumors (Astuti et al., 2001; Dammann et al., 2005). In prostate cancer, high frequency of RASSF1A methylation was reported in several studies and correlated with an advanced Gleason score (Table 1). However, methylation was also observed in several non-carcinoma specimen from matched tumor-normal samples (Kuzmin et al., 2002; Liu et al., 2002b; Maruyama et al., 2002; Florl et al., 2004; Kang et al., 2004; Singal et al., 2004; Woodson et al., 2004a,b). RASSF1A methylation was detected in different entities of soft tissue sarcoma, including leiomyosarcoma (Seidel et al., in press). In testicular germ cell tumors, most studies have detected that

RASSF1A methylation occurs frequently (Koul et al., 2002, 2004; Honorio et al., 2003b; Kawakami et al., 2003). Interestingly, RASSF1A methylation occurred more often in cisplatin-resistant tumors (Table 1). In thyroid cancer, RASSF1A hypermethylation was frequently detected in the more aggressive carcinomas (Schagdarsurengin et al., 2002; Xing et al., 2004). In papillary thyroid cancer an inverse correlation between RASSF1A methylation and BRAF mutation was reported (Table 1).

In general, RASSF1A methylation frequency is higher in cancer cell lines compared to the primary tumors. These additional changes could be attributed to *de novo* methylation which occurs when cells are kept in culture (Antequera et al., 1990; Jones et al., 1990; Smiraglia et al., 2001). In cell lines with an inactivated RASSF1A gene treatment with 5-aza-CdR reactivated the expression of RASSF1A (Table 1). In principal, methylation of RASSF1A is rarely detected in normal tissue, however methylation was also found in some non-cancerogenous tissue specimen. For instance RASSF1 methylation was detected in adjacent normal tissue of prostate, kidney, thyroid and liver cancer patients (Table 1). This methylation may represent infiltration of tumor cells into normal tissue or a field defect leading to carcinogenesis.

When quantitative methylation analysis was applied to determine the methylation level of RASSF1A in breast, prostate and thyroid tissue no significant methylation was detected in non-neoplastic tissue (Lehmann et al., 2002; Xing et al., 2004; Yegnasubramanian et al., 2004). Recently, hypermethylation of several cancer-related genes (e.g. p16, MGMT, DAP-kinase, RASSF1A, COX2 and RAR $\beta$ ) was detected in histologically negative bronchial margins of resected NSCLC (Guo et al., 2004). This hypermethylation may represent a field defect of preneoplastic changes that occurs early in carcinogenesis or may be related to aging (Issa, 1999; Waki et al., 2003).

Hypermethylation of the RASSF1A promoter and other tumor-related CpG islands were correlated with the exposure to smoke in lung cancer (Kim et al., 2003a; Toyooka et al., 2003, 2004). The effects of dietary folate and alcohol intake on promoter methylation were investigated in patients with sporadic colorectal cancer (van Engeland et al., 2003). Folate supplies a methyl group to convert homocysteine to methionine, which is then converted to S-adenosylmethionine, the methyl donor for a wide variety of biological substrates. Van Engeland et al. (2003) observed that the frequency of RASSF1A methylation is higher (25%) in cancer patients with low methyl donor dietary supplementation (low folate/high alcohol) compared to patients with high folate and low alcohol intake (15%). However, this difference was not significant for RASSF1A and several other tumor suppressor genes (van Engeland et al., 2003). In summary, RASSF1A methylation is one of the most frequent alterations detected in human tumors and

may play crucial roles in the initiation, promotion and progression of cancer originating from different tissue.

### **Correlation of RASSF1A methylation with tumor stage and patient survival**

Hypermethylation of RASSF1A occurs frequently in different tumor entities and therefore, aberrant RASSF1A promoter methylation is being widely studied as a biomarker for the prognosis of cancer patients. Various publications have demonstrated that the frequency of RASSF1A hypermethylation in different cancer entities is correlated with clinicopathological aspects, including higher grade of tumors or a reduced time of survival (Table 1). An association of hypermethylation of the promoter of RASSF1A with an advanced tumor stage was found in bladder cancer (Lee et al., 2001) and in gastric cancer (Byun et al., 2001). An increasing RASSF1A methylation frequency from grade II to grade IV glioblastoma was reported (Hesson et al., 2004). Kuroki et al. (2003) have demonstrated a significant correlation between RASSF1A hypermethylation and advanced tumor stage in esophageal squamous cell carcinoma (Table 1). In kidney cancer, RASSF1A methylation was correlated with high grade and papillary tumors (Dulaimi et al., 2004a). In prostate cancer, RASSF1A methylation was correlated with high serum PSA and high Gleason score (Liu et al., 2002b; Kang et al., 2004). A poorer prognosis of cancer patients with aberrant RASSF1A was reported in bladder cancer (Maruyama et al., 2001) and in prostate cancer (Maruyama et al., 2002). In NSCLC, several studies have significantly associated RASSF1A methylation with poor prognosis (stage 1 and stage 2) and advanced tumor stage (Burbee et al., 2001; Tomizawa et al., 2002; Endoh et al., 2003; Kim et al., 2003a). RASSF1A methylation was dominantly detected in lung tumors with vascular invasion or pleural involvement and was observed more frequently in poorly differentiated tumors than in well or moderately differentiated tumors (Tomizawa et al., 2002). Kim et al. (2003) have reported that RASSF1A methylation was associated with the age at starting smoking and impaired survival in NSCLC. A direct correlation between RASSF1A methylation and an earlier recurrence in NSCLC was reported by Endoh et al. (2003). It was observed that the methylation frequency was higher in metastases or in late states of certain cancer (Table 1). In lymph node metastasis of breast tumors, RASSF1A methylation was detected more frequent than in the primary breast carcinoma and hypermethylation was found in metastases in bone, brain and lung (Mehrotra et al., 2004). Schagdarsurengin et al. (2002) reported that RASSF1A methylation was more often in undifferentiated and medullary thyroid carcinomas. Müller et al. (2003) detected impaired outcome for breast cancer patients with methylation of the RASSF1A promoter in serum. Lee et al. (2004) reported that methylation of RASSF1A promoter is a late event in

colorectal neoplasia. In melanoma, hypermethylation of RASSF1A promoter increased during tumor progression and was more frequent in metastatic melanomas (Hoon et al., 2004). In contrast to these results, in testicular germ cell tumors (Honorio et al., 2003b) and in hepatocellular carcinoma (Yu et al., 2003) hypermethylation of the promoter of RASSF1A is an early event in tumorigenesis. In testicular germ cell tumors, an association between the resistance towards the chemo-therapeutic agent cisplatin and RASSF1A hypermethylation was observed (Koul et al., 2004). Taken together, RASSF1A methylation was often correlated with an advanced tumor stage and poor survival in different tumor entities.

### **Methylation of RASSF1A as a biomarker for tumor diagnosis**

The detection of tumors at early stages requires new approaches for characterization and identification of cancer-specific biomarkers and the establishment of reliable non-invasive methods for the detection of these biomarkers in body fluids. Methylation-specific PCR (MSP) has been used in several pilot studies to amplify cancer cell DNA obtained from bodily fluids and these DNA methylation analyses may serve as a powerful new tool for cancer diagnosis (Tsou et al., 2002). For example DNA isolated from serum of cancer patients was used to screen for tumors in the liver (Wong et al., 1999), in the lung (Esteller et al., 1999) and for head and neck cancer (Sanchez-Cespedes et al., 2000). Additionally, aberrant methylation of tumor-related genes was detected in DNA obtained from sputum or bronchial lavages of lung cancer patients (Belinsky et al., 1998; Ahrendt et al., 1999) and urine of prostate cancer (Cairns et al., 2001) and bladder cancer patients (Chan et al., 2003; Dulaimi et al., 2004b).

Several studies have analyzed the hypermethylation of the RASSF1A promoter in distinct bodily fluids. In nasopharyngeal carcinoma, Wong et al. (2003) found a RASSF1A methylation frequency of only 5% using MSP out of sera, whereas 65% of the primary tumors showed hypermethylation. A similar frequency of hypermethylation (3%) of RASSF1A in peripheral blood of nasopharyngeal carcinoma patients was detected by Chang et al. (2003), and additionally hypermethylation of RASSF1A was detected in nasopharyngeal swabs (33%) and mouth and throat rinsing fluids (37%) of cancer patients (Chang et al., 2003). In 4 out of 14 (29%) lung cancer patients who showed hypermethylation of RASSF1A, the bronchoalveolar lavages were positive for hypermethylated RASSF1A (Topaloglu et al., 2004). Zöchbauer-Müller et al. (2003) found hypermethylation of RASSF1A in bronchial brushes (6%), bronchoalveolar lavages (5%) and oropharyngeal brushes (2%). In serum of patients with NSCLC, Ramirez et al. (2003) detected a high frequency (34%) of RASSF1A methylated DNA and a high correlation between methylation in tumor tissue and serum









## RASSF1A in human cancer

( $p=0.0001$ ). Sputum of lung cancer patients is another body fluid, which was investigated for hypermethylated DNA of tumor suppressor genes (Belinsky et al., 2002; Honorio et al., 2003a). Honorio et al. (2003a,b) found that in 50% of SCLC and in 21% of NSCLC sputum samples a hypermethylation of RASSF1A was detectable. Belinsky et al. (2002) detected only a low frequency of RASSF1A methylation in the sputum of controls. In 50% sera of glioblastoma patients, RASSF1A methylation was observed and this correlated with the RASSF1A inactivation in the tumor tissue (Ramirez et al., 2003b). RASSF1A methylation was also investigated in the urine of patients with bladder and kidney cancer (Battagli et al., 2003; Chan et al., 2003; Dulaimi et al., 2004b). In 19 of 23 (82%) of patients with a RASSF1A methylated bladder cancer, Dulaimi et al., 2004 detected RASS1A hypermethylation in the urine samples. MSP used for detection of a panel of methylated promoters of cancer related genes (APC, RASSF1A and p14) in urine of bladder cancer patients showed 100% specificity and methylation of RASSF1A was not detected in the urine samples of controls (Dulaimi et al., 2004b). Chan et al. (2003) detected methylation of RASS1A in 7 out of 14 (50%) urine specimen and all positive probes showed also epigenetic inactivation of RASSF1A in the corresponding primary bladder tumors. In urine samples of patients with kidney tumor, Battagli et al. (2003) found in 25 out of 50 (50%) hypermethylated RASSF1A. Only for a single case, no RASSF1A methylation was detected in the urine despite of a methylated tumor (Battagli et al., 2003). In patients with Hodgkins' lymphoma, hypermethylation of the RASSF1A promoter occurred in two out of 22 (9%) sera, whereas the frequency of hypermethylation in primary tumors was 65% (Murray et al., 2004). In 22 samples of breast cancer, a panel of six genes (GSTP1, RAR $\beta$ 2, p16, p14, RASSF1A and DAP-kinase) was examined by Krassenstein et al. (2004) and in the corresponding nipple aspirates. At least one gene showed hypermethylation in its promoter region in the tumor samples and methylation of the same gene was detected in 18 out of 22 (82%) nipple aspirates (Krassenstein et al., 2004). In sera of breast cancer patients, hypermethylation of cancer-related genes was investigated by Müller et al. (2003). Methylation of the promoter region of RASSF1A was detected in 6 out of 26 (23%) associated with a worse prognosis and a poor outcome (Müller et al., 2003). Recently, hypermethylation of RASSF1A was also detected in tampons of patients with endometrial cancer (Fiegl et al., 2004). RASSF1A methylation was detected in bodily fluids (serum, plasma and peritoneal fluid) of ovarian cancer patients with 100% specificity (de Caceres et al., 2004). Methylation was undetectable in bodily fluids of patients with RASSF1A-unmethylated tumors and in controls. Taken together, RASSF1A hypermethylation is frequently detected in bodily fluids of cancer patients. Different frequencies in DNA methylation could be attributed to various DNA concentrations of

disseminating cancer cells in serum, sputum and other bodily fluids compared to the primary tumors and limitations in the sensitivity of the detection system. Methylation analysis of tumor-related genes in easily obtainable bodily fluids is a promising new experimental approach to screen putative cancer patients.

### The tumor suppressor function of RASSF1A

RASSF1A is involved in several growth regulating and apoptotic pathways and regulates cell proliferation, cellular integrity and cell death (Fig. 2). Ectopic expression of RASSF1A in cancer cell lines, which lack endogenous RASSF1A transcription resulted in reduced colony formation and/or anchorage-independent growth in soft agar in lung, kidney, prostate, glioma and nasopharyngeal cancer cell lines (Dammann et al., 2000; Burbee et al., 2001; Dreijerink et al., 2001; Kuzmin et al., 2002; Chow et al., 2004; Hesson et al., 2004; Li et al., 2004). In nude mice, human cancer cells lacking RASSF1A transcription formed larger tumors compared to the same cells expressing exogenous RASSF1A (Dammann et al., 2000; Burbee et al., 2001; Chow et al., 2004; Li et al., 2004). Mutant RASSF1A had only a reduced growth suppression activity *in vivo* and *in vitro* (Dreijerink et al., 2001; Li et al., 2004). Ectopic expression of the RASSF1C isoform showed only a modest reduction of cell viability *in vitro* (Ji et al., 2002). However, a recent report indicates that in a renal cancer cell line overexpression of RASSF1C inhibits

<b>Apoptosis</b> ↑	 NORE1 - MST1
	 CNK1 - MST1/2
<b>RASSF1A</b>	 Ras
↓ <b>Proliferation</b> <b>Cell integrity</b>	 Microtubule
	 PMCA4b
	 CDC20 - APC (cyclin A & B)
	 Cyclin D1
	 p120 <sup>E4F</sup>

**Fig. 2.** Summary of reported RASSF1A-mediated biological functions. The RASSF1A tumor suppressor induces apoptosis through its interaction with Ras, the novel Ras effector (NORE1) the connector enhancer of KSR (CNK) and the pro-apoptotic MST1 kinase. RASSF1A regulates cellular integrity and proliferation through its interaction with microtubules and CDC20 by inhibiting the anaphase promoting complex and the degradation of cyclin A and B. RASSF1A inhibits the epidermal growth factor dependent activation of Erk through the plasma membrane calmodulin-dependent calcium ATPase 4b (PNCA4b). RASSF1A inhibits the accumulation of cyclin D1 and interacts with the transcription factor p120<sup>E4F</sup>.

growth and induces cell cycle arrest (Li et al., 2004). To gain insight into RASSF1A function, expression profiles of cancer cell lines, which re-expressed RASSF1A were generated (Agathangelou et al., 2003). Agathangelou et al. (2004) have characterized several genes (e.g. ETS2, Cyclin D3, CDH2, DAPK1, TXN and CTSL) that may represent gene expression targets for RASSF1A. Shivakumar et al. (2002) have reported that RASSF1A can induce cell-cycle arrest by engaging the Rb family cell-cycle checkpoint. E7 papilloma virus protein-expressing cells are resistant to the RASSF1A-induced cell-cycle arrest (Shivakumar et al., 2002). RASSF1A also inhibits accumulation of native cyclin D1 (Fig. 2) and the RASSF1A-induced growth arrest can be relieved by ectopic expression of cyclins, but not by oncogenic Ras expression (Shivakumar et al., 2002).

Activated Ras is usually associated with enhanced proliferation, transformation and cell survival (Fig. 2). Ras also induces proliferation inhibitory effects (Bargagi and Feramisco, 1985; Serrano et al., 1997) and apoptosis (Mayo et al., 1997; Chen et al., 1998; Downward, 1998; Shao et al., 2000). Ras effectors, like RASSF1A, may be specialized to inhibit cell growth and to induce cell death and these inhibitory signaling pathways may need to be inactivated during carcinogenesis. Vos et al. (2000) have shown that RASSF1C binds Ras in a GTP-dependent manner and expression of RASSF1C induced apoptosis. This pro-apoptotic effect of RASSF1 is enhanced by activated Ras and inhibited by dominant negative Ras (Vos et al., 2000). Recent data indicate that in colorectal and pancreatic cancer, the inactivation of RASSF1A and activation of Ras are mutual exclusive (van Engeland et al., 2002; Dammann et al., 2003a), but in lung cancer this correlation was not significant (Tomizawa et al., 2002; Kim et al., 2003b; Ramirez et al., 2003a). In thyroid cancer, RASSF1A methylation occurred significantly when BRAF was not mutated (Xing et al., 2004).

Murine models of human cancer may expedite our understanding of carcinogenesis and *Rassf1a* knockout mice may help to dissect the tumorigenic process involved in the function of *Rassf1a*. Smith et al. (2002) have created a mouse with a 370 kb deletion of the region homologue to the 3p21.3, which includes *Rassf1a*. The homozygous deletion of this region is embryonic lethal in mouse (Smith et al., 2002). Recently, we have generated *Rassf1a* specific knockout mice and consistent with the tumor-suppressive role of RASSF1A, we have observed that these animals were prone to spontaneous and induced carcinogenesis (Tommasi et al., 2005). Interestingly, heterozygous and homozygous *Rassf1a* knockout mice were significantly more susceptible to spontaneous tumorigenesis ( $p < 0.05$  and  $p < 0.001$ , respectively) (Tommasi et al., 2005). When heterozygous and homozygous knockout mice were treated with two chemical carcinogens (benzopyrene and urethane), the *Rassf1a* deficient mice showed increased tumor multiplicity and tumor size compared to the

controls (Tommasi et al., 2005). Functional data indicate that *Rassf1a* knockout embryonic fibroblasts are more sensitive to induced microtubule instability relative to wildtype cells (Liu et al., 2003). These functional data and the *Rassf1a* knockout mice support the tumor suppressor role of RASSF1A observed in cancer.

Another homologue of RASSF1, which encodes a Ras association domain was characterized in mouse and human and was termed novel Ras effector (NORE1) (Vavvas et al., 1998; Tommasi et al., 2002). Recent data show that the RASSF1A-related Ras effector NORE1 may serve as a Ras-regulated tumor suppressor in lung cancer and melanoma (Vos et al., 2003; Aoyama et al., 2004) and epigenetic inactivation of NORE1 was detected in several cancers, including lung and kidney cancer (Tommasi et al., 2002; Chen et al., 2003b; Hesson et al., 2003). No correlation between RASSF1A methylation and NORE1 inactivation was reported (Hesson et al., 2003); however, in lung cancer hypermethylation of NORE1 occurs preferentially in the context of a wild-type K-ras (Irimia et al., 2004). Our results indicate that binding of RASSF1A to Ras may require heterodimerization with NORE1, and that RASSF1A binds to Ras only weakly by itself (Ortiz-Vega et al., 2002). RASSF1A and NORE1 may function in the same Ras-regulated pathway. Khokhlatchev et al. (2002) showed that RASSF1A and NORE1 interact with the pro-apoptotic kinase MST1, which mediates the apoptotic effect of activated Ras. MST1 is a member of the group II germinal center (protein serine/threonine) kinases and the NORE1/RASSF1-MST1 complex represents a novel Ras-regulated proapoptotic pathway (Khokhlatchev et al., 2002). Praskova et al. (2004) have reported that the MST1 kinase is regulated by robust auto-activation, which is mediated by auto-phosphorylation. Co-expression of RASSF1 and NORE1 suppressed the phosphorylation and therefore the auto-activation of MST1 (Praskova et al., 2004). Moreover, MST1 activity is stimulated by membrane recruitment and when bound to Ras. Recently, Rabizadeh et al. (2004) have reported that the scaffold protein CNK1 interacts with the tumor suppressor RASSF1A and augments RASSF1A induced cell death. The connector enhancer of KSR (CNK) is a c-Raf1 binding protein, which mediates Ras-induced Raf activation. CNK1 is an interaction partner of RASSF1 and represses growth of dividing cancer cells and initiates apoptosis through the MST1 (or MST2) pathway (Fig. 2). However, RASSF1C does not influence CNK1 induced apoptosis (Rabizadeh et al., 2004). In addition to a pro-proliferating role of CNK1 by activated Ras, CNK1 also participates in a pro-apoptotic pathway through its binding of the RASSF1A-MST complex (Rabizadeh et al., 2004).

In a yeast two-hybrid screen, RASSF1A was identified as a novel interaction partner of PMCA4b, a plasma membrane calmodulin-dependent calcium ATPase (Armesilla et al., 2004). The functionality of the interaction was demonstrated by inhibition of the epidermal growth factor-dependent activation of the Erk

pathway when PMCA4b and RASSF1 were coexpressed (Fig. 2). In another screen, p120E4F was identified as an interaction partner of RASSF1A (Fenton et al., 2004). p120E4F is an E1A-regulated transcription factor which interacts with the retinoblastoma protein, p14ARF and p53 and is involved in control of cell cycle arrest near the G1 transition. The G1 cell cycle arrest and S phase inhibition was enhanced by p120E4F in the presence of RASSF1A (Fenton et al., 2004).

Several different groups have reported that RASSF1A is a microtubule-binding protein, which regulates mitotic progression (Liu et al., 2002a, 2003; Dallol et al., 2004; Rong et al., 2004; Song et al., 2004; Vos et al., 2004). We have shown that RASSF1A co-localizes with microtubules in interphase and decorates spindles and centrosomes during mitosis (Liu et al., 2003). Upon binding to microtubules, RASSF1A has a strong cytoprotective activity against microtubule depolymerization induced by nocodazole *in vivo*. RASSF1A<sup>-/-</sup> cells were more sensitive against nocodazole induced G2/M arrest than wild type cells (Liu et al., 2003). The domain required for both microtubule association and stabilization was mapped to a fragment that contains the Ras association domain. Overexpression of RASSF1A induced mitotic arrest at metaphase with aberrant mitotic cells. These results were confirmed by several other groups (Liu et al., 2002a; Dallol et al., 2004; Rong et al., 2004; Song et al., 2004; Vos et al., 2004). RASSF1 was identified as an interaction partner of the C19ORF5 protein with high similarity to microtubule-associated proteins (MAP1A and MAP1B) (Liu et al., 2002a; Dallol et al., 2004). Dallol et al. (2004) have found that RASSF1A substitutions at codon 65 and 257 perturb the association with microtubules and these mutants are less potent inhibitors of DNA synthesis compared to the wildtype protein. Vos et al. (2004) have shown that a deletion mutant of RASSF1A, which lacks the microtubule association domain of RASSF1 is severely defective for the ability to promote cell cycle arrest and partially inhibits RASSF1A induced cell death. Interestingly, it was also shown that wild type RASSF1A and RASSF1C inhibit genomic instability induced by activated Ras (Vos et al., 2004). RASSF1A can regulate microtubule stability and induces G2/M arrest (Rong et al., 2004). Song et al. (2004) have reported that RASSF1A regulates mitosis by inhibiting the anaphase promoting complex (APC) through Cdc20 and induces G2-M arrest at pro-metaphase. RASSF1C had no effect on the APC-Cdc20 complex and cell cycle regulation (Song et al., 2004). The N-terminal region of RASSF1A interacts directly with Cdc20; however the C-terminus, which encodes the microtubule association domain, is also involved in the inhibition of APC (Song et al., 2004). After interaction with RASSF1A, Cdc20 is inhibited to activate APC and therefore APC is unable to degrade the mitotic cyclins A and B (Fig. 2). Inactivation of RASSF1A resulted in the acceleration of mitotic progression and in premature destruction of cyclin A and

B (Song et al., 2004). The function of RASSF1A is independent of the protein Emi1 (early mitotic inhibitor 1) and therefore Song et al. (2004) proposed that RASSF1A acts in early prometaphase, before activation of the spindle checkpoint and after Emi1 destruction to prevent the degradation of mitotic cyclins and to delay mitotic progression. Thus, RASSF1A may function as a crucial link between tumor suppression and mitotic cell division through a new mechanism (Jackson, 2004; Mathe, 2004). In summary, RASSF1A induces apoptosis and inhibits cellular proliferation through several pathways (Fig. 2). RASSF1A can regulate microtubule stability and control mitotic progression, presumably by modulating centrosomes and spindle function and by regulating the APC complex and accumulation of cyclins A, B and D1.

## Conclusions

Epigenetic inactivation of the RASSF1A tumor suppressor was found in a variety of primary human tumors including, bladder, brain, breast, cervix, colorectal, gastric, liver, kidney, lung, nasopharyngeal, ovarian, pancreatic, prostate and thyroid cancer. RASSF1A silencing was significantly associated with an advanced tumor stage and poorly differentiated tumors. Moreover, hypermethylation of RASSF1A correlated with poor prognosis and impaired survival of the cancer patient. Methylation analysis of the RASSF1A gene could serve as the basis of a diagnostic test for cancer. The observation that RASSF1A inactivation and K-ras activation are mutually exclusive events in the development of certain carcinomas could further pinpoint the function of RASSF1A as a negative effector of Ras. RASSF1A functions as *bona fide* tumor suppressor gene in cancer through several distinct pathways including apoptosis, genomic and microtubule stability and cell cycle regulation. The exact mechanism of its biological function is complex and may require additional Ras effectors like NORE1. Understanding the molecular function of RASSF1A may lead to the development of new anticancer drugs and the detection of the aberrant methylation of RASSF1A in patients bodily fluids may serve as promising biomarker for cancer diagnosis.

---

*Acknowledgements.* Data presented in this review were supported by BMBF grant FKZ 01ZZ0104, Land Sachsen-Anhalt, DFG grant DA552-1 to Reinhard Dammann, and NIH grant CA88873 to Gerd P. Pfeifer.

---

## References

- Agathangelou A., Bieche I., Ahmed-Choudhury J., Nicke B., Dammann R., Baksh S., Gao B., Minna J.D., Downward J., Maher E.R. and Latif F. (2003). Identification of novel gene expression targets for the Ras association domain family 1 (RASSF1A) tumor suppressor gene in non-small cell lung cancer and neuroblastoma. *Cancer Res.* 63, 5344-5351.

- Agathangelou A., Honorio S., Macartney D.P., Martinez A., Dallol A., Rader J., Fullwood P., Chauhan A., Walker R., Shaw J.A., Hosoe S., Lerman M.I., Minna J.D., Maher E.R. and Latif F. (2001). Methylation associated inactivation of RASSF1A from region 3p21.3 in lung, breast and ovarian tumours. *Oncogene* 20, 1509-1518.
- Ahrendt S.A., Chow J.T., Xu L.H., Yang S.C., Eisenberger C.F., Esteller M., Herman J.G., Wu L., Decker P.A., Jen J. and Sidransky D. (1999). Molecular detection of tumor cells in bronchoalveolar lavage fluid from patients with early stage lung cancer. *J. Natl. Cancer Inst.* 91, 332-339.
- Antequera F., Boyes J. and Bird A. (1990). High levels of de novo methylation and altered chromatin structure at CpG islands in cell lines. *Cell* 62, 503-514.
- Aoyama Y., Avruch J. and Zhang X.F. (2004). Nore1 inhibits tumor cell growth independent of Ras or the MST1/2 kinases. *Oncogene* 23, 3426-3433.
- Armesilla A.L., Williams J.C., Buch M.H., Pickard A., Emerson M., Cartwright E.J., Oceandy D., Vos M.D., Gillies S., Clark G.J. and Neyses L. (2004). Novel functional interaction between the plasma membrane Ca<sup>2+</sup> pump 4b and the proapoptotic tumor suppressor Ras-associated factor 1 (RASSF1). *J. Biol. Chem.* 279, 31318-31328.
- Astuti D., Agathangelou A., Honorio S., Dallol A., Martinsson T., Kogner P., Cummins C., Neumann H.P., Voutilainen R., Dahia P., Eng C., Maher E.R. and Latif F. (2001). RASSF1A promoter region CpG island hypermethylation in pheochromocytomas and neuroblastoma tumours. *Oncogene* 20, 7573-7577.
- Astuti D., Da Silva N.F., Dallol A., Gentle D., Martinsson T., Kogner P., Grundy R., Kishida T., Yao M., Latif F. and Maher E.R. (2004). SLIT2 promoter methylation analysis in neuroblastoma, Wilms' tumour and renal cell carcinoma. *Br. J. Cancer* 90, 515-521.
- Balana C., Ramirez J.L., Taron M., Roussos Y., Ariza A., Ballester R., Sarries C., Mendez P., Sanchez J.J. and Rosell R. (2003). O6-methyl-guanine-DNA methyltransferase methylation in serum and tumor DNA predicts response to 1,3-bis(2-chloroethyl)-1-nitrosourea but not to temozolamide plus cisplatin in glioblastoma multiforme. *Clin. Cancer Res.* 9, 1461-1468.
- Bar-Sagi D. and Feramisco J.R. (1985). Microinjection of the ras oncogene protein into PC12 cells induces morphological differentiation. *Cell* 42, 841-848.
- Battagli C., Uzzo R.G., Dulaimi E., Ibanez de Caceres I., Krassenstein R., Al-Saleem T., Greenberg R.E. and Cairns P. (2003). Promoter hypermethylation of tumor suppressor genes in urine from kidney cancer patients. *Cancer Res.* 63, 8695-8699.
- Belinsky S.A., Nikula K.J., Palmisano W.A., Michels R., Saccomanno G., Gabrielson E., Baylin S.B. and Herman J.G. (1998). Aberrant methylation of p16(INK4a) is an early event in lung cancer and a potential biomarker for early diagnosis. *Proc. Natl. Acad. Sci USA* 95, 11891-11896.
- Belinsky S.A., Palmisano W.A., Gilliland F.D., Crooks L.A., Divine K.K., Winters S.A., Grimes M.J., Harms H.J., Tellez C.S., Smith T.M., Moots P.P., Lechner J.F., Stidley C.A. and Crowell R.E. (2002). Aberrant promoter methylation in bronchial epithelium and sputum from current and former smokers. *Cancer Res.* 62, 2370-2377.
- Burbee D.G., Forgacs E., Zochbauer-Muller S., Shivakumar L., Fong K., Gao B., Randle D., Kondo M., Virmani A., Bader S., Sekido Y., Latif F., Milchgrub S., Toyooka S., Gazdar A.F., Lerman M.I., Zbarovsky E., White M. and Minna J.D. (2001). Epigenetic inactivation of RASSF1A in lung and breast cancers and malignant phenotype suppression. *J. Natl. Cancer Inst.* 93, 691-699.
- Byun D.S., Lee M.G., Chae K.S., Ryu B.G. and Chi S.G. (2001). Frequent epigenetic inactivation of rassf1a by aberrant promoter hypermethylation in human gastric adenocarcinoma. *Cancer Res.* 61, 7034-7038.
- Cairns P., Esteller M., Herman J.G., Schoenberg M., Jeronimo C., Sanchez-Cespedes M., Chow N.H., Grasso M., Wu L., Westra W.B. and Sidransky D. (2001). Molecular detection of prostate cancer in urine by GSTP1 hypermethylation. *Clin Cancer Res.* 7, 2727-2730.
- Chan M.W., Chan L.W., Tang N.L., Lo K.W., Tong J.H., Chan A.W., Cheung H.Y., Wong W.S., Chan P.S., Lai F.M. and To K.F. (2003). Frequent hypermethylation of promoter region of RASSF1A in tumor tissues and voided urine of urinary bladder cancer patients. *Int. J. Cancer* 104, 611-616.
- Chang H.W., Chan A., Kwong D.L., Wei W.I., Sham J.S. and Yuen A.P. (2003). Evaluation of hypermethylated tumor suppressor genes as tumor markers in mouth and throat rinsing fluid, nasopharyngeal swab and peripheral blood of nasopharyngeal carcinoma patient. *Int. J. Cancer* 105, 851-855.
- Chen C.M., Chen H.L., Hsiao T.H., Hsiao A.H., Shi H., Brock G.J., Wei S.H., Caldwell C.W., Yan P.S. and Huang T.H. (2003a). Methylation target array for rapid analysis of CpG island hypermethylation in multiple tissue genomes. *Am. J. Pathol.* 163, 37-45.
- Chen C.Y., Liou J., Forman L.W. and Faller D.V. (1998). Differential regulation of discrete apoptotic pathways by Ras. *J. Biol. Chem.* 273, 16700-16709.
- Chen J., Lui W.O., Vos M.D., Clark G.J., Takahashi M., Schoumans J., Khoo S.K., Petillo D., Lavery T., Sugimura J., Astuti D., Zhang C., Kagawa S., Maher E.R., Larsson C., Alberts A.S., Kanayama H.O. and Teh B.T. (2003b). The t(1;3) breakpoint-spanning genes LSAMP and NORE1 are involved in clear cell renal cell carcinomas. *Cancer Cell* 4, 405-413.
- Chow L.S., Lo K.W., Kwong J., To K.F., Tsang K.S., Lam C.W., Dammann R. and Huang D.P. (2004). RASSF1A is a target tumor suppressor from 3p21.3 in nasopharyngeal carcinoma. *Int. J. Cancer* 109, 839-847.
- Cohen Y., Singer G., Lavie O., Dong S.M., Beller U. and Sidransky D. (2003). The RASSF1A tumor suppressor gene is commonly inactivated in adenocarcinoma of the uterine cervix. *Clin. Cancer Res.* 9, 2981-2984.
- Dallol A., Agathangelou A., Fenton S.L., Ahmed-Choudhury J., Hesson L., Vos M.D., Clark G.J., Downward J., Maher E.R. and Latif F. (2004). RASSF1A interacts with microtubule-associated proteins and modulates microtubule dynamics. *Cancer Res.* 64, 4112-4116.
- Dammann R., Li C., Yoon J.H., Chin P.L., Bates S. and Pfeifer G.P. (2000). Epigenetic inactivation of a RAS association domain family protein from the lung tumour suppressor locus 3p21.3. *Nat. Genet.* 25, 315-319.
- Dammann R., Takahashi T. and Pfeifer G.P. (2001a). The CpG island of the novel tumor suppressor gene RASSF1A is intensely methylated in primary small cell lung carcinomas. *Oncogene* 20, 3563-3567.
- Dammann R., Yang G. and Pfeifer G.P. (2001b). Hypermethylation of the cpG island of Ras association domain family 1A (RASSF1A), a putative tumor suppressor gene from the 3p21.3 locus, occurs in a large percentage of human breast cancers. *Cancer Res.* 61, 3105-3109.
- Dammann R., Schagdarsurengin U., Liu L., Otto N., Gimm O., Dralle H., Boehm B.O., Pfeifer G.P. and Hoang-Vu C. (2003a). Frequent RASSF1A promoter hypermethylation and K-ras mutations in

*RASSF1A in human cancer*

- pancreatic carcinoma. *Oncogene* 22, 3806-3812.
- Dammann R., Schagdarsurengin U., Strunnikova M., Rastetter M., Seidel C., Liu L., Tommasi S. and Pfeifer G.P. (2003b). Epigenetic inactivation of the Ras-association domain family 1 (RASSF1A) gene and its function in human carcinogenesis. *Histol. Histopathol.* 18, 665-677.
- Dammann R., Schagdarsurengin U., Seidel C., Trumpler C., Hoang-Vu C., Gimm O., Dralle H., Pfeifer G.P. and Brauckhoff M. (2005). Frequent promoter methylation of tumor related genes in sporadic and MEN2-associated pheochromocytomas. *Exp. Clin. Endocrinol. Diabetes* 113, 1-7.
- de Caceres I., Battagli C., Esteller M., Herman J.G., Dulaimi E., Edelson M.I., Bergman C., Ehya H., Eisenberg B.L. and Cairns P. (2004). Tumor cell-specific BRCA1 and RASSF1A hypermethylation in serum, plasma, and peritoneal fluid from ovarian cancer patients. *Cancer Res.* 64, 6476-6481.
- Dhillon V.S., Aslam M. and Husain S.A. (2004). The contribution of genetic and epigenetic changes in granulosa cell tumors of ovarian origin. *Clin. Cancer Res.* 10, 5537-5545.
- Dong S.M., Sun D.I., Benoit N.E., Kuzmin I., Lerman M.I. and Sidransky D. (2003). Epigenetic inactivation of RASSF1A in head and neck cancer. *Clin. Cancer Res.* 9, 3635-3640.
- Downward J. (1998). Ras signalling and apoptosis. *Curr. Opin. Genet. Dev.* 8, 49-54.
- Dreijerink K., Braga E., Kuzmin I., Geil L., Duh F.M., Angeloni D., Zbar B., Lerman M.I., Stanbridge E.J., Minna J.D., Protopopov A., Li J., Kashuba V., Klein G. and Zabarovsky E.R. (2001). The candidate tumor suppressor gene, RASSF1A, from human chromosome 3p21.3 is involved in kidney tumorigenesis. *Proc. Natl. Acad. Sci. USA* 98, 7504-7509.
- Dulaimi E., De C., II, Uzzo R.G., Al-Saleem T., Greenberg R.E., Polascik T.J., Babb J.S., Grizzle W.E. and Cairns P. (2004a). Promoter hypermethylation profile of kidney cancer. *Clin Cancer Res.* 10, 3972-3979.
- Dulaimi E., Uzzo R.G., Greenberg R.E., Al-Saleem T. and Cairns P. (2004b). Detection of bladder cancer in urine by a tumor suppressor gene hypermethylation panel. *Clin. Cancer Res.* 10, 1887-1893.
- Ehrlich M., Jiang G., Fiala E., Dome J.S., Yu M.C., Long T.I., Youn B., Sohn O.S., Widschwendter M., Tomlinson G.E., Chintagumpala M., Champagne M., Parham D., Liang G., Malik K. and Laird P.W. (2002). Hypomethylation and hypermethylation of DNA in Wilms tumors. *Oncogene* 21, 6694-6702.
- Endoh H., Yatabe Y., Shimizu S., Tajima K., Kuwano H., Takahashi T. and Mitsudomi T. (2003). RASSF1A gene inactivation in non-small cell lung cancer and its clinical implication. *Int. J. Cancer* 106, 45-51.
- Esteller M., Sanchez-Cespedes M., Rosell R., Sidransky D., Baylin S.B. and Herman J.G. (1999). Detection of aberrant promoter hypermethylation of tumor suppressor genes in serum DNA from non-small cell lung cancer patients. *Cancer Res.* 59, 67-70.
- Fackler M.J., McVeigh M., Evron E., Garrett E., Mehrotra J., Polyak K., Sukumar S. and Argani P. (2003). DNA methylation of RASSF1A, HIN-1, RAR-beta, Cyclin D2 and Twist in situ and invasive lobular breast carcinoma. *Int. J. Cancer* 107, 970-975.
- Fenton S.L., Dallol A., Agathangelou A., Hesson L., Ahmed-Choudhury J., Baksh S., Sardet C., Dammann R., Minna J.D., Downward J., Maher E.R. and Latif F. (2004). Identification of the E1A-regulated transcription factor p120 E4F as an interacting partner of the RASSF1A candidate tumor suppressor gene. *Cancer Res.* 64, 102-107.
- Fiegl H., Gatttringer C., Widschwendter A., Schneitter A., Ramoni A., Sarlay D., Gaugg I., Goebel G., Muller H.M., Mueller-Holzner E., Marth C. and Widschwendter M. (2004). Methylated DNA collected by tampons--a new tool to detect endometrial cancer. *Cancer Epidemiol Biomarkers Prev.* 13, 882-888.
- Flori A.R., Steinhoff C., Muller M., Seifert H.H., Hader C., Engers R., Ackermann R. and Schulz W.A. (2004). Coordinate hypermethylation at specific genes in prostate carcinoma precedes LINE-1 hypomethylation. *Br. J. Cancer* 91, 985-994.
- Guo M., House M.G., Hooker C., Han Y., Heath E., Gabrielson E., Yang S.C., Baylin S.B., Herman J.G. and Brock M.V. (2004). Promoter hypermethylation of resected bronchial margins: a field defect of changes? *Clin. Cancer Res.* 10, 5131-5136.
- Harada K., Toyooka S., Maitra A., Maruyama R., Toyooka K.O., Timmons C.F., Tomlinson G.E., Mastrangelo D., Hay R.J., Minna J.D. and Gazdar A.F. (2002). Aberrant promoter methylation and silencing of the RASSF1A gene in pediatric tumors and cell lines. *Oncogene* 21, 4345-4349.
- Hasegawa M., Nelson H.H., Peters E., Ringstrom E., Posner M. and Kelsey K.T. (2002). Patterns of gene promoter methylation in squamous cell cancer of the head and neck. *Oncogene* 21, 4231-4236.
- Herman J.G. and Baylin S.B. (2003). Gene silencing in cancer in association with promoter hypermethylation. *N. Engl. J. Med.* 349, 2042-2054.
- Hesson L., Bieche I., Krex D., Criniere E., Hoang-Xuan K., Maher E.R. and Latif F. (2004). Frequent epigenetic inactivation of RASSF1A and BLU genes located within the critical 3p21.3 region in gliomas. *Oncogene* 23, 2408-2419.
- Hesson L., Dallol A., Minna J.D., Maher E.R. and Latif F. (2003). NORE1A, a homologue of RASSF1A tumour suppressor gene is inactivated in human cancers. *Oncogene* 22, 947-954.
- Hogg R.P., Honorio S., Martinez A., Agathangelou A., Dallol A., Fullwood P., Weichselbaum R., Kuo M.J., Maher E.R. and Latif F. (2002). Frequent 3p allele loss and epigenetic inactivation of the RASSF1A tumour suppressor gene from region 3p21.3 in head and neck squamous cell carcinoma. *Eur. J. Cancer* 38, 1585-1592.
- Honorio S., Agathangelou A., Schuermann M., Pankow W., Viacava P., Maher E.R. and Latif F. (2003a). Detection of RASSF1A aberrant promoter hypermethylation in sputum from chronic smokers and ductal carcinoma in situ from breast cancer patients. *Oncogene* 22, 147-150.
- Honorio S., Agathangelou A., Wernert N., Rothe M., Maher E.R. and Latif F. (2003b). Frequent epigenetic inactivation of the RASSF1A tumour suppressor gene in testicular tumours and distinct methylation profiles of seminoma and nonseminoma testicular germ cell tumours. *Oncogene* 22, 461-466.
- Hoon D.S., Spugnardi M., Kuo C., Huang S.K., Morton D.L. and Taback B. (2004). Profiling epigenetic inactivation of tumor suppressor genes in tumors and plasma from cutaneous melanoma patients. *Oncogene* 23, 4014-4022.
- Horiguchi K., Tomizawa Y., Tosaka M., Ishiuchi S., Kurihara H., Mori M. and Saito N. (2003). Epigenetic inactivation of RASSF1A candidate tumor suppressor gene at 3p21.3 in brain tumors. *Oncogene* 22, 7862-7865.
- House M.G., Guo M., Efron D.T., Lillemoe K.D., Cameron J.L., Syphard J.E., Hooker C.M., Abraham S.C., Montgomery E.A., Herman J.G. and Brock M.V. (2003a). Tumor suppressor gene hypermethylation as a predictor of gastric stromal tumor behavior. *J. Gastrointest.*

- Surg. 7, 1004-1014.
- House M.G., Herman J.G., Guo M.Z., Hooker C.M., Schulick R.D., Lillemoe K.D., Cameron J.L., Hruban R.H., Maitra A. and Yeo C.J. (2003b). Aberrant hypermethylation of tumor suppressor genes in pancreatic endocrine neoplasms. *Ann. Surg.* 238, 423-431.
- Irimia M., Fraga M.F., Sanchez-Cespedes M. and Esteller M. (2004). CpG island promoter hypermethylation of the Ras-effector gene NORE1A occurs in the context of a wild-type K-ras in lung cancer. *Oncogene* 23, 8695-8699.
- Issa J.P. (1999). Aging, DNA methylation and cancer. *Crit. Rev. Oncol. Hematol.* 32, 31-43.
- Jackson P.K. (2004). Linking tumor suppression, DNA damage and the anaphase-promoting complex. *Trends Cell Biol.* 14, 331-334.
- Ji L., Nishizaki M., Gao B., Burbee D., Kondo M., Kamibayashi C., Xu K., Yen N., Atkinson E.N., Fang B., Lerman M.I., Roth J.A. and Minna J.D. (2002). Expression of several genes in the human chromosome 3p21.3 homozygous deletion region by an adenovirus vector results in tumor suppressor activities in vitro and in vivo. *Cancer Res.* 62, 2715-2720.
- Jones P.A. and Baylin S.B. (2002). The fundamental role of epigenetic events in cancer. *Nat. Rev. Genet.* 3, 415-428.
- Jones P.A., Wolkowicz M.J., Rideout W.M., 3rd, Gonzales F.A., Marziasz C.M., Coetzee G.A. and Tapscott S.J. (1990). De novo methylation of the MyoD1 CpG island during the establishment of immortal cell lines. *Proc. Natl. Acad. Sci. USA* 87, 6117-6121.
- Kaelin W.G. Jr. and Maher E.R. (1998). The VHL tumour-suppressor gene paradigm. *Trends Genet.* 14, 423-426.
- Kang G.H., Lee H.J., Hwang K.S., Lee S., Kim J.H. and Kim J.S. (2003a). Aberrant CpG island hypermethylation of chronic gastritis, in relation to aging, gender, intestinal metaplasia, and chronic inflammation. *Am. J. Pathol.* 163, 1551-1556.
- Kang G.H., Lee S., Kim J.S. and Jung H.Y. (2003b). Profile of aberrant CpG island methylation along multistep gastric carcinogenesis. *Lab. Invest.* 83, 519-526.
- Kang G.H., Lee S., Kim W.H., Lee H.W., Kim J.C., Rhyu M.G. and Ro J.Y. (2002). Epstein-barr virus-positive gastric carcinoma demonstrates frequent aberrant methylation of multiple genes and constitutes CpG island methylator phenotype-positive gastric carcinoma. *Am. J. Pathol.* 160, 787-794.
- Kang G.H., Lee S., Lee H.J. and Hwang K.S. (2004). Aberrant CpG island hypermethylation of multiple genes in prostate cancer and prostatic intraepithelial neoplasia. *J. Pathol.* 202, 233-240.
- Kawakami T., Okamoto K., Kataoka A., Koizumi S., Iwaki H., Sugihara H., Reeve A.E., Ogawa O. and Okada Y. (2003). Multipoint methylation analysis indicates a distinctive epigenetic phenotype among testicular germ cell tumors and testicular malignant lymphomas. *Genes Chromosomes Cancer.* 38, 97-101.
- Khokhlatchev A., Rabizadeh S., Xavier R., Nedwidek M., Chen T., Zhang X.F., Seed B. and Avruch J. (2002). Identification of a novel Ras-regulated proapoptotic pathway. *Curr. Biol.* 12, 253-265.
- Killary A.M., Wolf M.E., Giambrenardi T.A. and Naylor S.L. (1992). Definition of a tumor suppressor locus within human chromosome 3p21-p22. *Proc. Natl. Acad. Sci. USA* 89, 10877-10881.
- Kim D.H., Kim J.S., Ji Y.I., Shim Y.M., Kim H., Han J. and Park J. (2003a). Hypermethylation of RASSF1A promoter is associated with the age at starting smoking and a poor prognosis in primary non-small cell lung cancer. *Cancer Res.* 63, 3743-3746.
- Kim D.H., Kim J.S., Park J.H., Lee S.K., Ji Y.I., Kwon Y.M., Shim Y.M., Han J. and Park J. (2003b). Relationship of Ras association domain family 1 methylation and K-ras mutation in primary non-small cell lung cancer. *Cancer Res.* 63, 6206-6211.
- Kim S.T., Lim D.S., Canman C.E. and Kastan M.B. (1999). Substrate specificities and identification of putative substrates of ATM kinase family members. *J. Biol. Chem.* 274, 37538-37543.
- Kok K., Naylor S.L. and Buys C.H. (1997). Deletions of the short arm of chromosome 3 in solid tumors and the search for suppressor genes. *Adv. Cancer Res.* 71, 27-92.
- Koul S., Houldsworth J., Mansukhani M.M., Donadio A., McKiernan J.M., Reuter V.E., Bosl G.J., Chaganti R.S. and Murty V.V. (2002). Characteristic promoter hypermethylation signatures in male germ cell tumors. *Mol. Cancer.* 1, 8.
- Koul S., McKiernan J.M., Narayan G., Houldsworth J., Bacik J., Dobrzynski D.L., Assaad A.M., Mansukhani M., Reuter V.E., Bosl G.J., Chaganti R.S. and Murty V.V. (2004). Role of promoter hypermethylation in Cisplatin treatment response of male germ cell tumors. *Mol. Cancer.* 3, 16.
- Krassenstein R., Sauter E., Dulaimi E., Battagli C., Ehya H., Klein-Szanto A. and Cairns P. (2004). Detection of breast cancer in nipple aspirate fluid by CpG island hypermethylation. *Clin. Cancer Res.* 10, 28-32.
- Kuroki T., Trapasso F., Yendamuri S., Matsuyama A., Alder H., Mori M. and Croce C.M. (2003). Promoter hypermethylation of RASSF1A in esophageal squamous cell carcinoma. *Clin. Cancer Res.* 9, 1441-1445.
- Kuzmin I., Gillespie J.W., Protopopov A., Geil L., Dreijerink K., Yang Y., Vocke C.D., Duh F.M., Zabarovsky E., Minna J.D., Rhim J.S., Emmert-Buck M.R., Linehan W.M. and Lerman M.I. (2002). The RASSF1A tumor suppressor gene is inactivated in prostate tumors and suppresses growth of prostate carcinoma cells. *Cancer Res.* 62, 3498-3502.
- Kuzmin I., Liu L., Dammann R., Geil L., Stanbridge E.J., Wilczynski S.P., Lerman M.I. and Pfeifer G.P. (2003). Inactivation of RAS association domain family 1A gene in cervical carcinomas and the role of human papillomavirus infection. *Cancer Res.* 63, 1888-1893.
- Kwong J., Lo K.W., To K.F., Teo P.M., Johnson P.J. and Huang D.P. (2002). Promoter hypermethylation of multiple genes in nasopharyngeal carcinoma. *Clin. Cancer Res.* 8, 131-137.
- Lee M.G., Kim H.Y., Byun D.S., Lee S.J., Lee C.H., Kim J.I., Chang S.G. and Chi S.G. (2001). Frequent epigenetic inactivation of rassf1a in human bladder carcinoma. *Cancer Res.* 61, 6688-6692.
- Lee S., Hwang K.S., Lee H.J., Kim J.S. and Kang G.H. (2004). Aberrant CpG island hypermethylation of multiple genes in colorectal neoplasia. *Lab. Invest.* 84, 884-893.
- Lee S., Lee H.J., Kim J.H., Lee H.S., Jang J.J. and Kang G.H. (2003). Aberrant CpG island hypermethylation along multistep hepatocarcinogenesis. *Am. J. Pathol.* 163, 1371-1378.
- Lehmann U., Langer F., Feist H., Glockner S., Hasemeier B. and Kreipe H. (2002). Quantitative assessment of promoter hypermethylation during breast cancer development. *Am. J. Pathol.* 160, 605-612.
- Lerman M.I. and Minna J.D. (2000). The 630-kb lung cancer homozygous deletion region on human chromosome 3p21.3: identification and evaluation of the resident candidate tumor suppressor genes. The International lung cancer chromosome 3p21.3 Tumor Suppressor Gene Consortium. *Cancer Res.* 60, 6116-6133.
- Li J., Wang F., Protopopov A., Malyukova A., Kashuba V., Minna J.D., Lerman M.I., Klein G. and Zabarovsky E. (2004). Inactivation of RASSF1C during in vivo tumor growth identifies it as a tumor



*RASSF1A in human cancer*

- suppressor gene. *Oncogene*. 23, 5941-5949.
- Li J., Zhang Z., Dai Z., Popkie A.P., Plass C., Morrison C., Wang Y. and You M. (2003). RASSF1A promoter methylation and Kras2 mutations in non small cell lung cancer. *Neoplasia* 5, 362-366.
- Lim S., Yang M.H., Park J.H., Nojima T., Hashimoto H., Unni K.K. and Park Y.K. (2003). Inactivation of the RASSF1A in osteosarcoma. *Oncol. Rep.* 10, 897-901.
- Lindsey J.C., Lusher M.E., Anderton J.A., Bailey S., Gilbertson R.J., Pearson A.D., Ellison D.W. and Clifford S.C. (2004). Identification of tumour-specific epigenetic events in medulloblastoma development by hypermethylation profiling. *Carcinogenesis* 25, 661-668.
- Liu L., Amy V., Liu G. and McKeehan W.L. (2002a). Novel complex integrating mitochondria and the microtubular cytoskeleton with chromosome remodeling and tumor suppressor RASSF1 deduced by in silico homology analysis, interaction cloning in yeast, and colocalization in cultured cells. *In Vitro Cell Dev. Biol. Anim.* 38, 582-594.
- Liu L., Tommasi S., Lee D.H., Dammann R. and Pfeifer G.P. (2003). Control of microtubule stability by the RASSF1A tumor suppressor. *Oncogene* 22, 8125-8136.
- Liu L., Yoon J.H., Dammann R. and Pfeifer G.P. (2002b). Frequent hypermethylation of the RASSF1A gene in prostate cancer. *Oncogene* 21, 6835-6840.
- Lo K.W., Kwong J., Hui A.B., Chan S.Y., To K.F., Chan A.S., Chow L.S., Teo P.M., Johnson P.J. and Huang D.P. (2001). High frequency of promoter hypermethylation of RASSF1A in nasopharyngeal carcinoma. *Cancer Res.* 61, 3877-3881.
- Lusher M.E., Lindsey J.C., Latif F., Pearson A.D., Ellison D.W. and Clifford S.C. (2002). Biallelic epigenetic inactivation of the RASSF1A tumor suppressor gene in medulloblastoma development. *Cancer Res.* 62, 5906-5911.
- Maruya S., Issa J.P., Weber R.S., Rosenthal D.I., Haviland J.C., Lotan R. and El-Naggar A.K. (2004). Differential methylation status of tumor-associated genes in head and neck squamous carcinoma: incidence and potential implications. *Clin. Cancer Res.* 10, 3825-3830.
- Maruyama R., Toyooka S., Toyooka K.O., Harada K., Virmani A.K., Zochbauer-Muller S., Farinas A.J., Vakar-Lopez F., Minna J.D., Sagalowsky A., Czerniak B. and Gazdar A.F. (2001). Aberrant promoter methylation profile of bladder cancer and its relationship to clinicopathological features. *Cancer Res.* 61, 8659-8663.
- Maruyama R., Toyooka S., Toyooka K.O., Virmani A.K., Zochbauer-Muller S., Farinas A.J., Minna J.D., McConnell J., Frenkel E.P. and Gazdar A.F. (2002). Aberrant promoter methylation profile of prostate cancers and its relationship to clinicopathological features. *Clin Cancer Res.* 8, 514-519.
- Maruyama R., Sugio K., Yoshino I., Maehara Y. and Gazdar A.F. (2004). Hypermethylation of FHIT as a prognostic marker in nonsmall cell lung carcinoma. *Cancer* 100, 1472-1477.
- Mathe E. (2004). RASSF1A, the new guardian of mitosis. *Nat. Genet.* 36, 117-118.
- Mayo M.W., Wang C.Y., Cogswell P.C., Rogers-Graham K.S., Lowe S.W., Der C.J. and Baldwin A.S., Jr. (1997). Requirement of NF-kappaB activation to suppress p53-independent apoptosis induced by oncogenic Ras. *Science* 278, 1812-1815.
- Mehrotra J., Vali M., McVeigh M., Kominsky S.L., Fackler M.J., Lahti-Domenici J., Polyak K., Sacchi N., Garrett-Mayer E., Argani P. and Sukumar S. (2004). Very high frequency of hypermethylated genes in breast cancer metastasis to the bone, brain, and lung. *Clin. Cancer Res.* 10, 3104-3109.
- Morrissey C., Martinez A., Zatyka M., Agathangelou A., Honorio S., Astuti D., Morgan N.V., Moch H., Richards F.M., Kishida T., Yao M., Schraml P., Latif F. and Maher E.R. (2001). Epigenetic inactivation of the RASSF1A 3p21.3 tumor suppressor gene in both clear cell and papillary renal cell carcinoma. *Cancer Res.* 61, 7277-7281.
- Muller H.M., Widschwendter A., Fiegl H., Ivarsson L., Goebel G., Perkmann E., Marth C. and Widschwendter M. (2003). DNA methylation in serum of breast cancer patients: an independent prognostic marker. *Cancer Res.* 63, 7641-7645.
- Murray P.G., Qiu G.H., Fu L., Waites E.R., Srivastava G., Heys D., Agathangelou A., Latif F., Grundy R.G., Mann J.R., Starczynski J., Crocker J., Parkes S.E., Ambinder R.F., Young L.S. and Tao Q. (2004). Frequent epigenetic inactivation of the RASSF1A tumor suppressor gene in Hodgkin's lymphoma. *Oncogene* 23, 1326-1331.
- Newton A.C. (1995). Protein kinase C. Seeing two domains. *Curr. Biol.* 5, 973-976.
- Ng M.H., Lau K.M., Wong W.S., To K.W., Cheng S.H., Tsang K.S., Chan N.P., Kho B.C., Lo K.W., Tong J.H., Lam C.W. and Chan J.C. (2003). Alterations of RAS signalling in Chinese multiple myeloma patients: absent BRAF and rare RAS mutations, but frequent inactivation of RASSF1A by transcriptional silencing or expression of a non-functional variant transcript. *Br. J. Haematol.* 123, 637-645.
- Ortiz-Vega S., Khokhlatchev A., Nedwied M., Zhang X.F., Dammann R., Pfeifer G.P. and Avruch J. (2002). The putative tumor suppressor RASSF1A homodimerizes and heterodimerizes with the Ras-GTP binding protein Nore1. *Oncogene* 21, 1381-1390.
- Pfeifer G.P., Yoon J.H., Liu L., Tommasi S., Wilczynski S.P. and Dammann R. (2002). Methylation of the RASSF1A gene in human cancers. *Biol. Chem.* 383, 907-914.
- Ponting C.P. and Benjamin D.R. (1996). A novel family of Ras-binding domains. *Trends Biochem. Sci.* 21, 422-425.
- Praskova M., Khokhlatchev A., Ortiz-Vega S. and Avruch J. (2004). Regulation of the MST1 kinase by autophosphorylation, by the growth inhibitory proteins, RASSF1 and NORE1, and by Ras. *Biochem. J.* 381, 453-462.
- Rabizadeh S., Xavier R.J., Ishiguro K., Bernabeortiz J., Lopez-Illasaca M., Khokhlatchev A., Mollahan P., Pfeifer G.P., Avruch J. and Seed B. (2004). The scaffold protein CNK1 interacts with the tumor suppressor RASSF1A and augments RASSF1A-induced cell death. *J. Biol. Chem.* 279, 29247-29254.
- Ramirez J.L., Sarries C., de Castro P.L., Roig B., Queralt C., Escuin D., de Aguirre I., Sanchez J.M., Manzano J.L., Margeli M., Sanchez J.J., Astudillo J., Taron M. and Rosell R. (2003a). Methylation patterns and K-ras mutations in tumor and paired serum of resected non-small-cell lung cancer patients. *Cancer Lett.* 193, 207-216.
- Ramirez J.L., Taron M., Balana C., Sarries C., Mendez P., de Aguirre I., Nunez L., Roig B., Queralt C., Botia M. and Rosell R. (2003b). Serum DNA as a tool for cancer patient management. *Rocz Akad. Med. Bialymst.* 48, 34-41.
- Rathi A., Virmani A.K., Schorge J.O., Elias K.J., Maruyama R., Minna J.D., Mok S.C., Girard L., Fishman D.A. and Gazdar A.F. (2002). Methylation profiles of sporadic ovarian tumors and nonmalignant ovaries from high-risk women. *Clin. Cancer Res.* 8, 3324-3331.
- Reifenberger J., Knobbe C.B., Sterzinger A.A., Blaschke B., Schulte K.W., Ruzicka T. and Reifenberger G. (2004). Frequent alterations of Ras signaling pathway genes in sporadic malignant melanomas. *Int. J. Cancer* 109, 377-384.
- Rong R., Jin W., Zhang J., Saeed Sheikh M. and Huang Y. (2004).

*RASSF1A in human cancer*

- Tumor suppressor RASSF1A is a microtubule-binding protein that stabilizes microtubules and induces G(2)/M arrest. *Oncogene* 23, 8216-8230.
- Sanchez-Cespedes M., Esteller M., Wu L., Nawroz-Danish H., Yoo G.H., Koch W.M., Jen J., Herman J.G. and Sidransky D. (2000). Gene promoter hypermethylation in tumors and serum of head and neck cancer patients. *Cancer Res.* 60, 892-895.
- Schagdarsurengin U., Gimm O., Hoang-Vu C., Dralle H., Pfeifer G.P. and Dammann R. (2002). Frequent epigenetic silencing of the CpG island promoter of RASSF1A in thyroid carcinoma. *Cancer Res.* 62, 3698-3701.
- Schagdarsurengin U., Wilkens L., Steinemann D., Flemming P., Kreipe H.H., Pfeifer G.P., Schlegelberger B. and Dammann R. (2003). Frequent epigenetic inactivation of the RASSF1A gene in hepatocellular carcinoma. *Oncogene* 22, 1866-1871.
- Seidel C., Bartel F., Rastetter M., Blümke K., Würl P., Taubert H. and Dammann R. (in press). Alterations of cancer-related genes in soft tissue sarcomas: hypermethylation of RASSF1A is frequently detected in leiomyosarcoma and associated with poor prognosis in sarcoma. *Int. J. Cancer*
- Seidl S., Ackermann J., Kaufmann H., Keck A., Nosslinger T., Zielinski C.C., Drach J. and Zochbauer-Muller S. (2004). DNA-methylation analysis identifies the E-cadherin gene as a potential marker of disease progression in patients with monoclonal gammopathies. *Cancer* 100, 2598-2606.
- Sekido Y., Ahmadian M., Wistuba, II, Latif F., Bader S., Wei M.H., Duh F.M., Gazdar A.F., Lerman M.I. and Minna J.D. (1998). Cloning of a breast cancer homozygous deletion junction narrows the region of search for a 3p21.3 tumor suppressor gene. *Oncogene* 16, 3151-3157.
- Serrano M., Lin A.W., McCurrach M.E., Beach D. and Lowe S.W. (1997). Oncogenic ras provokes premature cell senescence associated with accumulation of p53 and p16INK4a. *Cell* 88, 593-602.
- Shao J., Sheng H., DuBois R.N. and Beauchamp R.D. (2000). Oncogenic Ras-mediated cell growth arrest and apoptosis are associated with increased ubiquitin-dependent cyclin D1 degradation. *J. Biol. Chem.* 275, 22916-22924.
- Shivakumar L., Minna J., Sakamaki T., Pestell R. and White M.A. (2002). The RASSF1A tumor suppressor blocks cell cycle progression and inhibits cyclin D1 accumulation. *Mol. Cell Biol.* 22, 4309-4318.
- Singal R., Ferdinand L., Reis I.M. and Schlesselman J.J. (2004). Methylation of multiple genes in prostate cancer and the relationship with clinicopathological features of disease. *Oncol. Rep.* 12, 631-637.
- Smiraglia D.J., Rush L.J., Fruhwald M.C., Dai Z., Held W.A., Costello J.F., Lang J.C., Eng C., Li B., Wright F.A., Caligiuri M.A. and Plass C. (2001). Excessive CpG island hypermethylation in cancer cell lines versus primary human malignancies. *Hum. Mol. Genet.* 10, 1413-1419.
- Smith A.J., Xian J., Richardson M., Johnstone K.A. and Rabbitts P.H. (2002). Cre-loxP chromosome engineering of a targeted deletion in the mouse corresponding to the 3p21.3 region of homozygous loss in human tumours. *Oncogene* 21, 4521-4529.
- Song M.S., Song S.J., Ayad N.G., Chang J.S., Lee J.H., Hong H.K., Lee H., Choi N., Kim J., Kim H., Kim J.W., Choi E.J., Kirschner M.W. and Lim D.S. (2004). The tumour suppressor RASSF1A regulates mitosis by inhibiting the APC-Cdc20 complex. *Nat. Cell Biol.* 6, 129-137.
- Sozzi G., Veronese M.L., Negrini M., Baffa R., Cotticelli M.G., Inoue H., Tornielli S., Pilotti S., De Gregorio L., Pastorino U., Pierotti M.A., Ohta M., Huebner K. and Croce C.M. (1996). The FHIT gene 3p14.2 is abnormal in lung cancer. *Cell* 85, 17-26.
- Spugnardi M., Tommasi S., Dammann R., Pfeifer G.P. and Hoon D.S. (2003). Epigenetic inactivation of RAS association domain family protein 1 (RASSF1A) in malignant cutaneous melanoma. *Cancer Res.* 63, 1639-1643.
- To K.F., Leung W.K., Lee T.L., Yu J., Tong J.H., Chan M.W., Ng E.K., Chung S.C. and Sung J.J. (2002). Promoter hypermethylation of tumor-related genes in gastric intestinal metaplasia of patients with and without gastric cancer. *Int. J. Cancer* 102, 623-628.
- Todd S., Franklin W.A., Varella-Garcia M., Kennedy T., Hilliker C.E. Jr., Hahner L., Anderson M., Wiest J.S., Drabkin H.A. and Gemmill R.M. (1997). Homozygous deletions of human chromosome 3p in lung tumors. *Cancer Res.* 57, 1344-1352.
- Tomizawa Y., Kohno T., Kondo H., Otsuka A., Nishioka M., Niki T., Yamada T., Maeshima A., Yoshimura K., Saito R., Minna J.D. and Yokota J. (2002). Clinicopathological significance of epigenetic inactivation of RASSF1A at 3p21.3 in stage I lung adenocarcinoma. *Clin. Cancer Res.* 8, 2362-2368.
- Tommasi S., Dammann R., Jin S.G., Zhang Xi X.F., Avruch J. and Pfeifer G.P. (2002). RASSF3 and NORE1: identification and cloning of two human homologues of the putative tumor suppressor gene RASSF1. *Oncogene* 21, 2713-2720.
- Tommasi S., Dammann R., Zhang Z., Wang Y., Liu L., Tsark W.M., Wilczynski S.P., Li J., You M. and Pfeifer G.P. (2005). Tumor susceptibility of RASSF1A knockout mice. *Cancer Res.* 65, 92-98.
- Tong J.H., Tsang R.K., Lo K.W., Woo J.K., Kwong J., Chan M.W., Chang A.R., van Hasselt C.A., Huang D.P. and To K.F. (2002). Quantitative Epstein-Barr virus DNA analysis and detection of gene promoter hypermethylation in nasopharyngeal (NP) brushing samples from patients with NP carcinoma. *Clin. Cancer Res.* 8, 2612-2619.
- Topaloglu O., Hoque M.O., Tokumaru Y., Lee J., Ratovitski E., Sidransky D. and Moon C.S. (2004). Detection of promoter hypermethylation of multiple genes in the tumor and bronchoalveolar lavage of patients with lung cancer. *Clin. Cancer Res.* 10, 2284-2288.
- Toyooka S., Pass H.I., Shivapurkar N., Fukuyama Y., Maruyama R., Toyooka K.O., Gilcrease M., Farinas A., Minna J.D. and Gazdar A.F. (2001a). Aberrant methylation and simian virus 40 tag sequences in malignant mesothelioma. *Cancer Res.* 61, 5727-5730.
- Toyooka S., Toyooka K.O., Maruyama R., Virmani A.K., Girard L., Miyajima K., Harada K., Ariyoshi Y., Takahashi T., Sugio K., Brambilla E., Gilcrease M., Minna J.D. and Gazdar A.F. (2001b). DNA methylation profiles of lung tumors. *Mol. Cancer Ther.* 1, 61-67.
- Toyooka S., Carbone M., Toyooka K.O., Bocchetta M., Shivapurkar N., Minna J.D. and Gazdar A.F. (2002). Progressive aberrant methylation of the RASSF1A gene in simian virus 40 infected human mesothelial cells. *Oncogene* 21, 4340-4344.
- Toyooka S., Maruyama R., Toyooka K.O., McLerran D., Feng Z., Fukuyama Y., Virmani A.K., Zochbauer-Muller S., Tsukuda K., Sugio K., Shimizu N., Shimizu K., Lee H., Chen C.Y., Fong K.M., Gilcrease M., Roth J.A., Minna J.D. and Gazdar A.F. (2003). Smoke exposure, histologic type and geography-related differences in the methylation profiles of non-small cell lung cancer. *Int. J. Cancer* 103, 153-160.
- Toyooka S., Suzuki M., Tsuda T., Toyooka K.O., Maruyama R.,

*RASSF1A in human cancer*

- Tsukuda K., Fukuyama Y., Iizasa T., Fujisawa T., Shimizu N., Minna J.D. and Gazdar A.F. (2004). Dose effect of smoking on aberrant methylation in non-small cell lung cancers. *Int. J. Cancer* 110, 462-464.
- Tsou J.A., Hagen J.A., Carpenter C.L. and Laird-Offringa I.A. (2002). DNA methylation analysis: a powerful new tool for lung cancer diagnosis. *Oncogene* 21, 5450-5461.
- van Engeland M., Roemen G.M., Brink M., Pachen M.M., Weijnenberg M.P., de Bruine A.P., Arends J.W., van den Brandt P.A., de Goeij A.F. and Herman J.G. (2002). K-ras mutations and RASSF1A promoter methylation in colorectal cancer. *Oncogene* 21, 3792-3795.
- van Engeland M., Weijnenberg M.P., Roemen G.M., Brink M., de Bruine A.P., Goldbohm R.A., van den Brandt P.A., Baylin S.B., de Goeij A.F. and Herman J.G. (2003). Effects of dietary folate and alcohol intake on promoter methylation in sporadic colorectal cancer: the Netherlands cohort study on diet and cancer. *Cancer Res.* 63, 3133-3137.
- Vavvas D., Li X., Avruch J. and Zhang X.F. (1998). Identification of Nore1 as a potential Ras effector. *J. Biol. Chem.* 273, 5439-5442.
- Vos M.D., Ellis C.A., Bell A., Birrer M.J. and Clark G.J. (2000). Ras uses the novel tumor suppressor RASSF1 as an effector to mediate apoptosis. *J. Biol. Chem.* 275, 35669-35672.
- Vos M.D., Martinez A., Elam C., Dallol A., Taylor B.J., Latif F. and Clark G.J. (2004). A role for the RASSF1A tumor suppressor in the regulation of tubulin polymerization and genomic stability. *Cancer Res.* 64, 4244-4250.
- Vos M.D., Martinez A., Ellis C.A., Vallecorsa T. and Clark G.J. (2003). The pro-apoptotic Ras effector Nore1 may serve as a Ras-regulated tumor suppressor in the lung. *J. Biol. Chem.* 278, 21938-21943.
- Wagner K.J., Cooper W.N., Grundy R.G., Caldwell G., Jones C., Wadey R.B., Morton D., Schofield P.N., Reik W., Latif F. and Maher E.R. (2002). Frequent RASSF1A tumour suppressor gene promoter methylation in Wilms' tumour and colorectal cancer. *Oncogene* 21, 7277-7282.
- Waki T., Tamura G., Sato M. and Motoyama T. (2003). Age-related methylation of tumor suppressor and tumor-related genes: an analysis of autopsy samples. *Oncogene* 22, 4128-4133.
- Wei M.H., Latif F., Bader S., Kashuba V., Chen J.Y., Duh F.M., Sekido Y., Lee C.C., Geil L., Kuzmin I., Zabarovsky E., Klein G., Zbar B., Minna J.D. and Lerman M.I. (1996). Construction of a 600-kilobase cosmid clone contig and generation of a transcriptional map surrounding the lung cancer tumor suppressor gene (TSG) locus on human chromosome 3p21.3: progress toward the isolation of a lung cancer TSG. *Cancer Res.* 56, 1487-1492.
- Wistuba II, Behrens C., Virmani A.K., Mele G., Milchgrub S., Girard L., Fondon J.W., 3rd, Garner H.R., McKay B., Latif F., Lerman M.I., Lam S., Gazdar A.F. and Minna J.D. (2000). High resolution chromosome 3p allelotyping of human lung cancer and preneoplastic/preinvasive bronchial epithelium reveals multiple, discontinuous sites of 3p allele loss and three regions of frequent breakpoints. *Cancer Res.* 60, 1949-1960.
- Wong I.H., Chan J., Wong J. and Tam P.K. (2004a). Ubiquitous aberrant RASSF1A promoter methylation in childhood neoplasia. *Clin. Cancer Res.* 10, 994-1002.
- Wong I.H., Lo Y.M., Zhang J., Liew C.T., Ng M.H., Wong N., Lai P.B., Lau W.Y., Hjelm N.M. and Johnson P.J. (1999). Detection of aberrant p16 methylation in the plasma and serum of liver cancer patients. *Cancer Res.* 59, 71-73.
- Wong N., Li L., Tsang K., Lai P.B., To K.F. and Johnson P.J. (2002). Frequent loss of chromosome 3p and hypermethylation of RASSF1A in cholangiocarcinoma. *J. Hepatol.* 37, 633-639.
- Wong T.S., Kwong D.L., Sham J.S., Wei W.I., Kwong Y.L. and Yuen A.P. (2004b). Quantitative plasma hypermethylated DNA markers of undifferentiated nasopharyngeal carcinoma. *Clin. Cancer Res.* 10, 2401-2406.
- Wong T.S., Tang K.C., Kwong D.L., Sham J.S., Wei W.I., Kwong Y.L. and Yuen A.P. (2003). Differential gene methylation in undifferentiated nasopharyngeal carcinoma. *Int. J. Oncol.* 22, 869-874.
- Woodson K., Gillespie J., Hanson J., Emmert-Buck M., Phillips J.M., Linehan W.M. and Tangrea J.A. (2004a). Heterogeneous gene methylation patterns among pre-invasive and cancerous lesions of the prostate: a histopathologic study of whole mount prostate specimens. *Prostate* 60, 25-31.
- Woodson K., Hanson J. and Tangrea J. (2004b). A survey of gene-specific methylation in human prostate cancer among black and white men. *Cancer Lett.* 205, 181-188.
- Xian J., Clark K.J., Fordham R., Pannell R., Rabbitts T.H. and Rabbitts P.H. (2001). Inadequate lung development and bronchial hyperplasia in mice with a targeted deletion in the Dutt1/Robo1 gene. *Proc. Natl. Acad. Sci. USA* 98, 15062-15066.
- Xing M., Cohen Y., Mambo E., Tallini G., Udelsman R., Ladenson P.W. and Sidransky D. (2004). Early occurrence of RASSF1A hypermethylation and its mutual exclusion with BRAF mutation in thyroid tumorigenesis. *Cancer Res.* 64, 1664-1668.
- Yamakawa K., Takahashi T., Horio Y., Murata Y., Takahashi E., Hibi K., Yokoyama S., Ueda R. and Nakamura Y. (1993). Frequent homozygous deletions in lung cancer cell lines detected by a DNA marker located at 3p21.3-p22. *Oncogene* 8, 327-330.
- Yanagawa N., Tamura G., Oizumi H., Takahashi N., Shimazaki Y. and Motoyama T. (2003). Promoter hypermethylation of tumor suppressor and tumor-related genes in non-small cell lung cancers. *Cancer Sci.* 94, 589-592.
- Yegnasubramanian S., Kowalski J., Gonzalgo M.L., Zahurak M., Piantadosi S., Walsh P.C., Bova G.S., De Marzo A.M., Isaacs W.B. and Nelson W.G. (2004). Hypermethylation of CpG islands in primary and metastatic human prostate cancer. *Cancer Res* 64, 1975-1986.
- Yoon J.H., Dammann R. and Pfeifer G.P. (2001). Hypermethylation of the CpG island of the RASSF1A gene in ovarian and renal cell carcinomas. *Int. J. Cancer* 94, 212-217.
- Yu M.Y., Tong J.H., Chan P.K., Lee T.L., Chan M.W., Chan A.W., Lo K.W. and To K.F. (2003). Hypermethylation of the tumor suppressor gene RASSF1A and frequent concomitant loss of heterozygosity at 3p21 in cervical cancers. *Int. J. Cancer* 105, 204-209.
- Zhong S., Yeo W., Tang M.W., Wong N., Lai P.B. and Johnson P.J. (2003). Intensive hypermethylation of the CpG island of Ras association domain family 1A in hepatitis B virus-associated hepatocellular carcinomas. *Clin. Cancer Res.* 9, 3376-3382.
- Zochbauer-Muller S., Lam S., Toyooka S., Virmani A.K., Toyooka K.O., Seidl S., Minna J.D. and Gazdar A.F. (2003). Aberrant methylation of multiple genes in the upper aerodigestive tract epithelium of heavy smokers. *Int. J. Cancer* 107, 612-616.